

# The Tunable Wideband Receiver

TWB Design, Construction, and Observations



Dave Typinski, Richard Flagg, Wes Greenman  
Radio Jove Meeting, July 2, 2014, NRAO Green Bank

---

# TWB Design History

The TWB is designed to capture individual Jovian S bursts so that we may determine the drift rates and have a look at the morphology of these bursts.

The point behind a tunable wideband receiver is to be able to see a wider IF bandwidth at one time. We want to do that because it in turn enables us to make a high speed spectrogram across the whole IF bandwidth of the receiver.

For example, a garden variety HF receiver has an IF BW of about 6 kHz in AM mode. That is far too narrow to see much structural detail of S bursts. We want to see high speed spectra of multiple MHz in width – hence the TWB.

The ability to tune the receiver is required because S bursts are not confined to a fixed sub-section of the HF band. We must have the ability to chase them where they appear, as they happen.

While it is true that one could perform this feat by digitizing the whole HF band at a very high sample rate, doing so is an expensive venture. We chose the less expensive option of building on previous designs by using an analog RF section to get the signal into a 2 MHz wide IF, then we digitized that IF output.

Let's take a look at the evolution of the design of the TWB receiver.

- **TWB Mark I, 1971–1980** (Flagg)
  - 500 kHz BW, fixed freq downconverters or HP 606
  - Sangamo 600 kHz mag tape & Saicor audio SA
  - Used on UFRO Helix, 26.3 array, Chile, Arecibo
  
- **TWB Mark II, 1990–2005** (Greenman)
  - 1.3 MHz BW, 17–37 MHz tuning range
  - Honeywell 2 MHz mag tape or Gage digitizer
  - Used on UFRO TP array, 26.3 array
  
- **TWB Mark III, 2013–present** (Flagg, Greenman, Typinski)
  - 2 MHz BW, 16–32 MHz tuning range
  - Gage Digitizer
  - Used on AJ4CO TFD array

#### TWB Mark I, 1971–1980

500 kHz BW, fixed freq downconverters or HP 606  
Sangamo 600 kHz mag tape & Saicor audio SA  
Used on UFRO Helix, 26.3 array, Chile, Arecibo

#### TWB Mark II, 1990–2005

1.3 MHz BW, 17–37 MHz tuning range  
Honeywell 2 MHz mag tape or Gage digitizer  
Used on UFRO TP array, 26.3 array

#### TWB Mark III, 2013–present

2 MHz BW, 16–32 MHz tuning range  
Gage Digitizer  
Used on AJ4CO TFD array

---

# The TWB Mark III Hardware



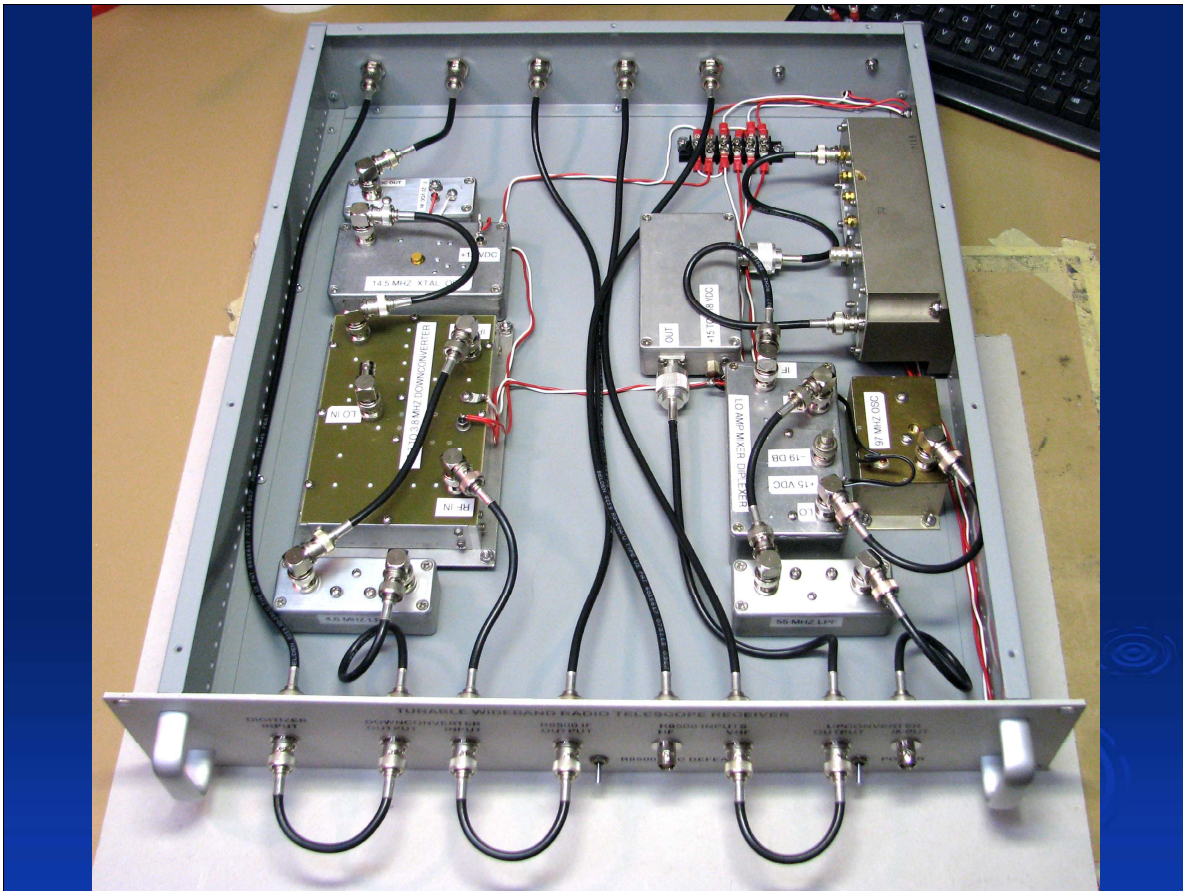

TWB chassis layout.

19" rack chassis from Par-Metal Products in New Jersey. Very reasonable prices (~ \$100 for this 2U x 20" deep aluminum & steel chassis).



TWB chassis front and rear panels.

The TWB connections were designed for

- a) easy connection of test equipment to each stage of the receiver, and
- b) so that separate TWB components (Icom R8500 and the digitizer) could be easily used separately for other experiments if/when desired.

Now that we've seen what the TWB looks like, let's get into what it does and what makes it go.

## TWB Mark III General Specs

- Tuneable from 17 to 33 MHz
- 2 MHz bandwidth (IF out  $f_c = 3.8$  MHz)
- ~40 dB dynamic range
- ~8 dB noise figure (~1,700 K)
- 10 MSamp/sec ADC, 12-bit resolution
- FFT post-processing
- $\Delta T = 205 \mu\text{s}$  (FFT block = 2,048)
- RBW = 4.88 kHz, 411 output bins

The TWB project started in July, 2013. The three of us put considerable effort into considering what had gone before and what we could do with what we had available. After seemingly endless hours of discussion, designing, testing, and building, the instrument worked beautifully the first time out (November, 2013), capturing some nice Io-B S bursts in all their high speed glory.

Richard Flagg built the amp and mixer modules and several filters. Wes Greenman built more filters, particularly those with the fiddly Cauer designs. Dr Higgins graciously provided a digitizer. Dave Typinski built the AGC defeat system, fabricated the chassis, tested the performance of the hardware, and wrote the software necessary to display the data in RSS and create audio.

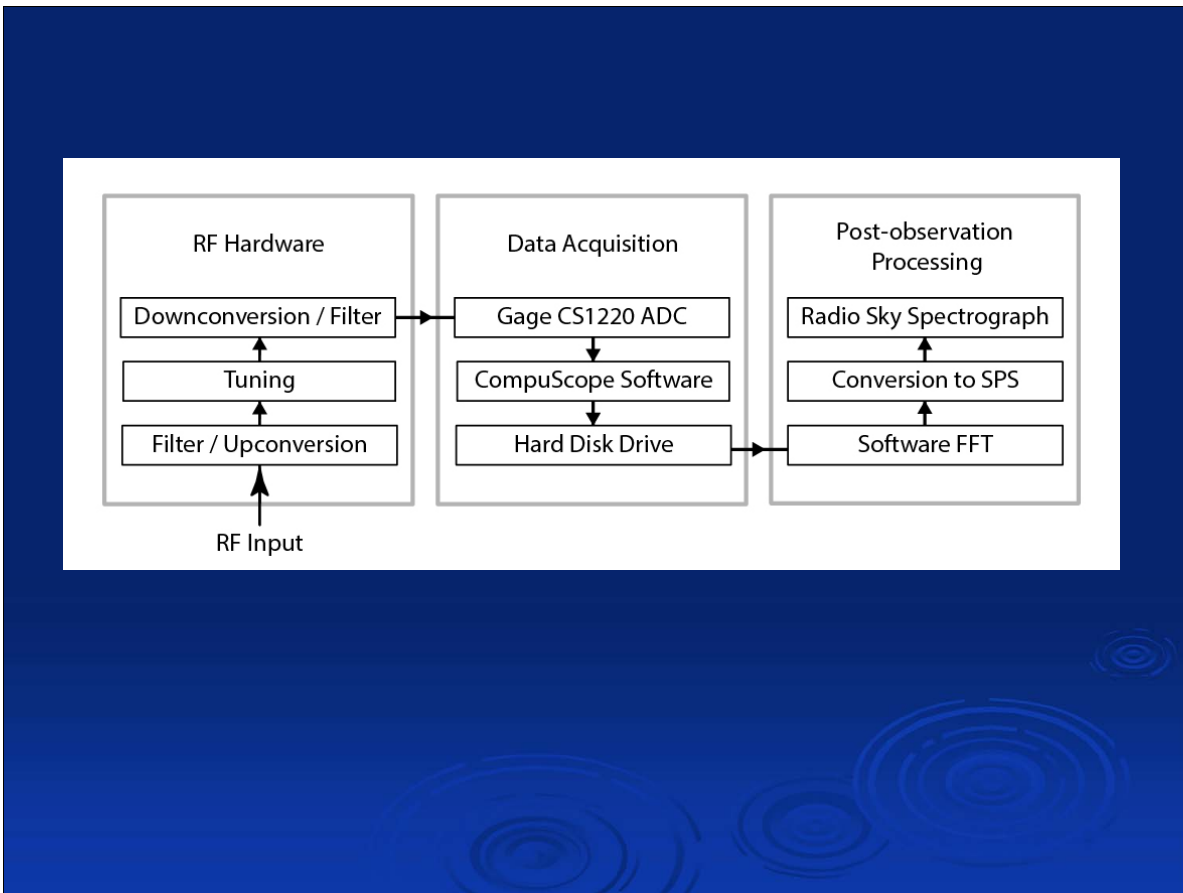

Basic data flow within the TWB system.

The TWB is really a system of hardware and software, not just the receiver. It involves the receiver, the digitizer, and post-processing of the recorded data.



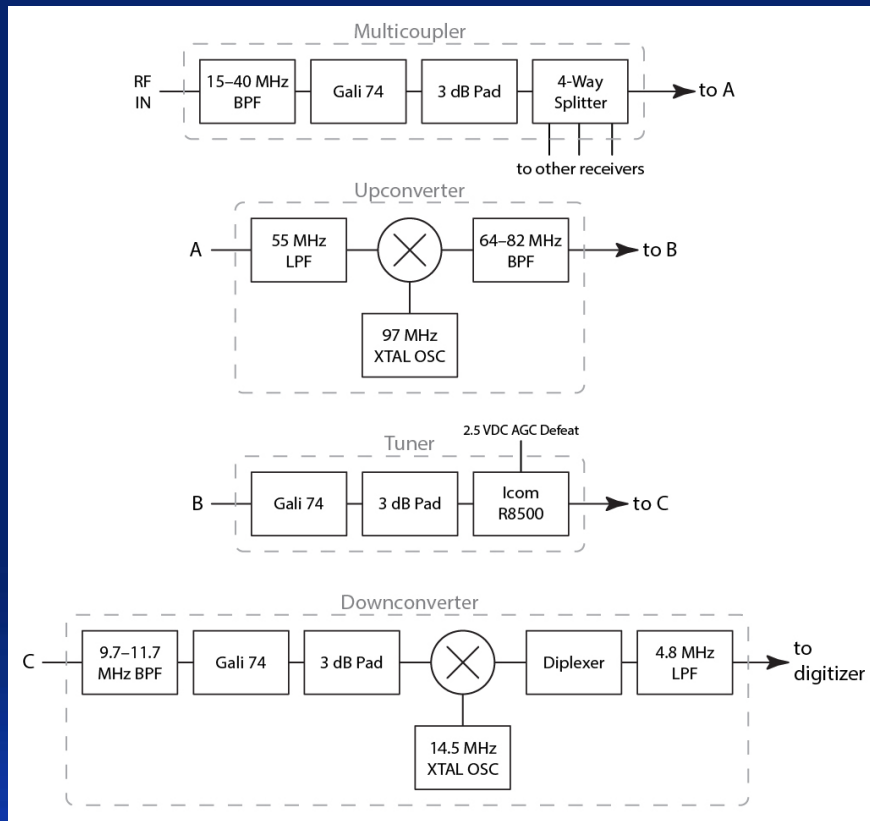

Functional block diagram of the TWB's RF section. We will take a closer look at each of these blocks, but first let's look at some analyses of the receiver design.

**TWB System Analysis**  
Typinski, October 2013

Change only the values in WHITE cells  
(including the device names)

Component #	MC Block			Upconv Block			Tuning Block			Downconverter Block								
	TFD Feedpoint	Balun + Feed line	MC BPF 55-60	MC Amp Gall 74	MC 12 dB Pad	55 MHz LPF	Upconv. Mixer	64-82 MHz BPF	Monopole Gall 74	9 dB Pad	R8500 Tuner	9.9-11.8 MHz BPF	Gall 74	3 dB Pad	Downconv Mixer	Diplexer	4.8 MHz LPF	
$T_0$ (K)	290																	
Gain (dB)		-3.0	-1.0	+25.0	-12.0	-1.0	-6.0	-1.0	+25.0	-9.0	+8.0	-0.5	+26.0	-3.0	-5.0	-0.5	-0.5	
NF (dB)	9.2			4.0					4.0		7.0		4.0					
Input Compression Point (dBm)				-15.0			-3.0		-15.0		-30.0		-15.0		-3.0			
F				2.5					2.5		5.0		2.5					
G				316.2					316.2		6.3		398.1					
Cumulative G				316.2	316.2	316.2	316.2	316.2	100000.0	100000.0	6.3E+05	6.3E+05	2.5E+09	2.5E+09	2.5E+09	2.5E+09	2.5E+09	
L	2.0	1.3		15.8	1.3	4.0	1.3		7.9		1.1		2.0	3.2	1.1	1.1		
Cumulative L	2.0	2.5	2.5	39.8	50.1	199.5	251.2	251.2	1995.3	1995.3	2238.7	2238.7	4466.8	14125.4	15848.9	17782.8		
$T_{ant}$ (K)		289	75	438	4,306	75	865	75	438	2,014	1,163	35	438	289	627	35	35	
Contribution to $T_{sys}$ (K)		289	150	1,101	34	9	137	47	348	5	23	0	2	0	0	0	0	
$T_{sys}$ (K)		2,146																
$T_{eff} = T_{ant} + T_{sys}$ (MK)		10,000	5,012	3,981	1259,348	79,459	63,117	15,854	12,594	3982,538	501,372	3163,443	2819,421	1122432	562549	177893	158548	141306
BW (MHz)		100	100	25	25	25	25	18	18	18	4	2	2	2	2	2	2	2
Signal Level (dBm) at component output		-49	-52	-59	-34	-46	-47	-53	-55	-30	-39	-38	-41	-15	-18	-23	-24	-24
$V_{RMS}$ (mV)		0.8	0.6	0.3	4.7	1.2	1.0	0.5	0.4	7.0	2.5	3.0	2.0	39.4	27.9	15.7	14.8	14.0
$V_{PEAK}$ (mV)		1.2	0.8	0.4	6.6	1.7	1.5	0.7	0.6	9.9	3.5	4.2	2.8	55.7	39.4	22.2	20.9	19.7

TWB noise figure and signal level analysis.

We used this spreadsheet to

- a) Ensure no amplifiers would go into compression at the highest expected signal levels. Conversion from temperature to dBm and  $V_{peak}$  is calculated into 50 ohms over the prevailing bandwidth at each stage. We used a 10 MK antenna temperature because that's about 10 dB above the hotter S bursts we felt we were likely to see; it gave us some room in case we saw S bursts that were hotter than we thought. As such, the TWB can accommodate even a fairly strong 10 MK solar burst and still have about 8 dB headroom before compression.
- b) Calculate the theoretical noise figure to make sure we stayed well below the galactic background. At 1,700 K, the TWB's expected noise contribution is 10 dB below the GB at 33 MHz and 17 dB below the GB at 16 MHz.
- c) Calculate the amount of gain or attenuation needed at each stage while
  - a) maintaining a low noise figure
  - b) staying out of compression, and
  - c) having enough overall amplification to drive the digitizer.
- d) To determine the appropriate range to use on the Gage digitizer (which is rated in peak voltage). We use the  $\pm 50$  mV range (100 mV peak to peak) on the digitizer, which works great.

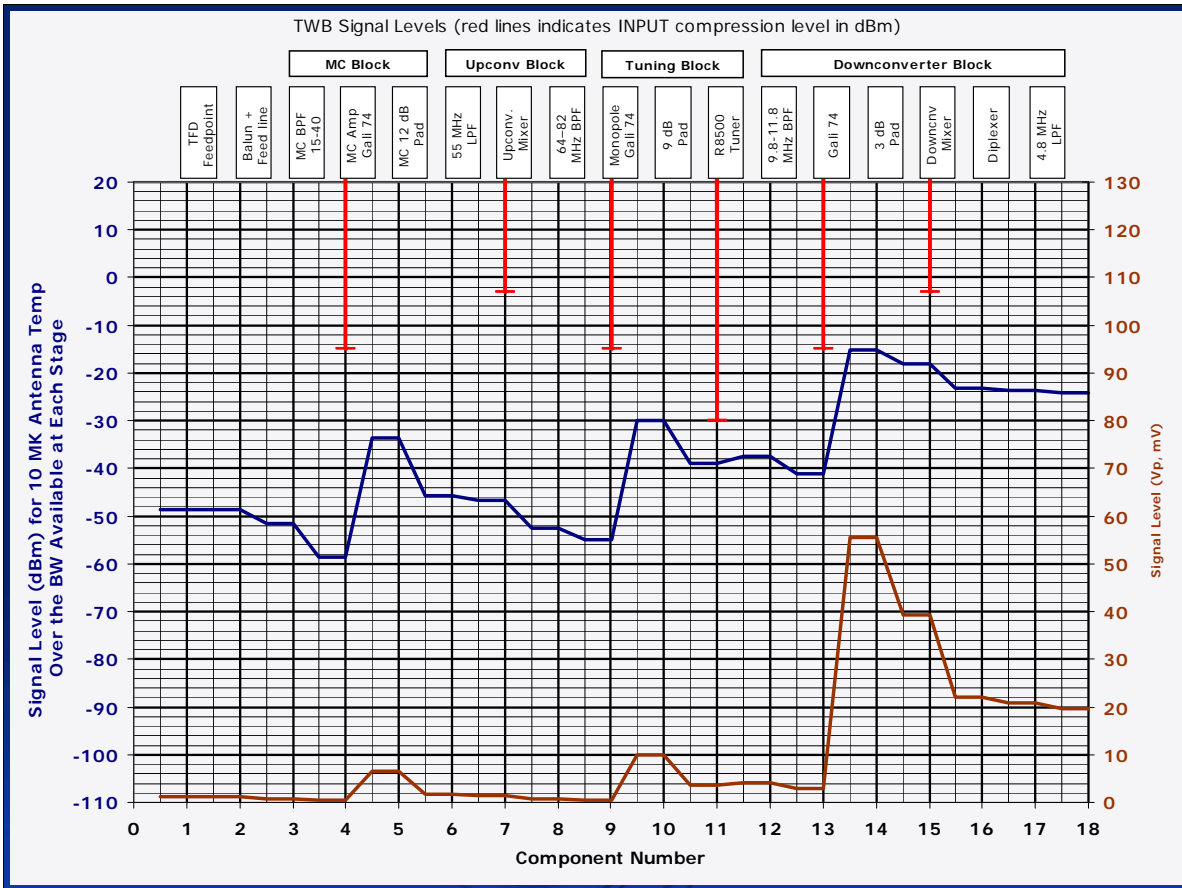

RF signal level analysis.

The blue trace (dBm) goes with the blue numbers on the LH vertical axis.

The brown trace (V<sub>peak</sub>) goes with the brown numbers on the RH vertical axis.

Conversion from temperature to dBm and V<sub>peak</sub> is calculated into 50 ohms over the prevailing bandwidth at each stage.

With a broadband 10 MK input temperature, the receiver is still ~8 dB from compression. Expected output for this signal level is -24 dBm or 20 mV peak (40 mV p-p).

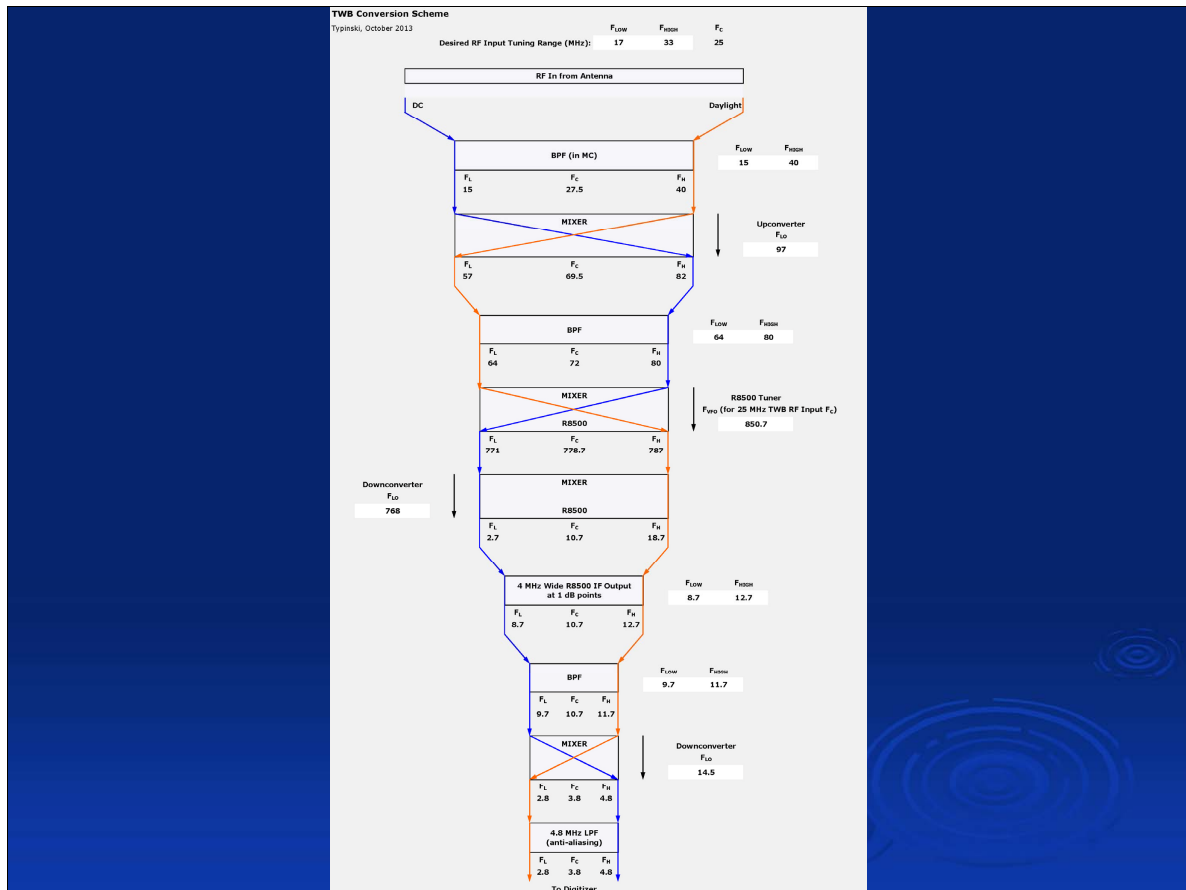

TWB conversion and filtering scheme.

- 1) Input BPF in the multicoupler, 15 to 40 MHz
- 2) Upconverter mixer, high side injection, LO = 97 MHz
- 3) Image and LO rejection BPF 64 to 80 MHz (real world useful upper limit is ~ 82 MHz)
- 4) Icom R8500 1<sup>st</sup> mixer, high side injection, VFO = 841.7 to 858.7 MHz (tuning stage)
- 5) Icom R8500 2<sup>nd</sup> mixer, low side injection, LO = 768 MHz
- 6) Icom R8500 BPF equivalent in IF output, 8.7 to 12.7 MHz @ 1 dB points
- 7) IF BW BPF 9.7 to 11.7 MHz
- 8) Downconverter, high side injection, LO = 14.5 MHz
- 9) Image rejection, LO rejection, and anti-aliasing LPF, 4.8 MHz

Let's now take a look at each functional block of the TWB system.

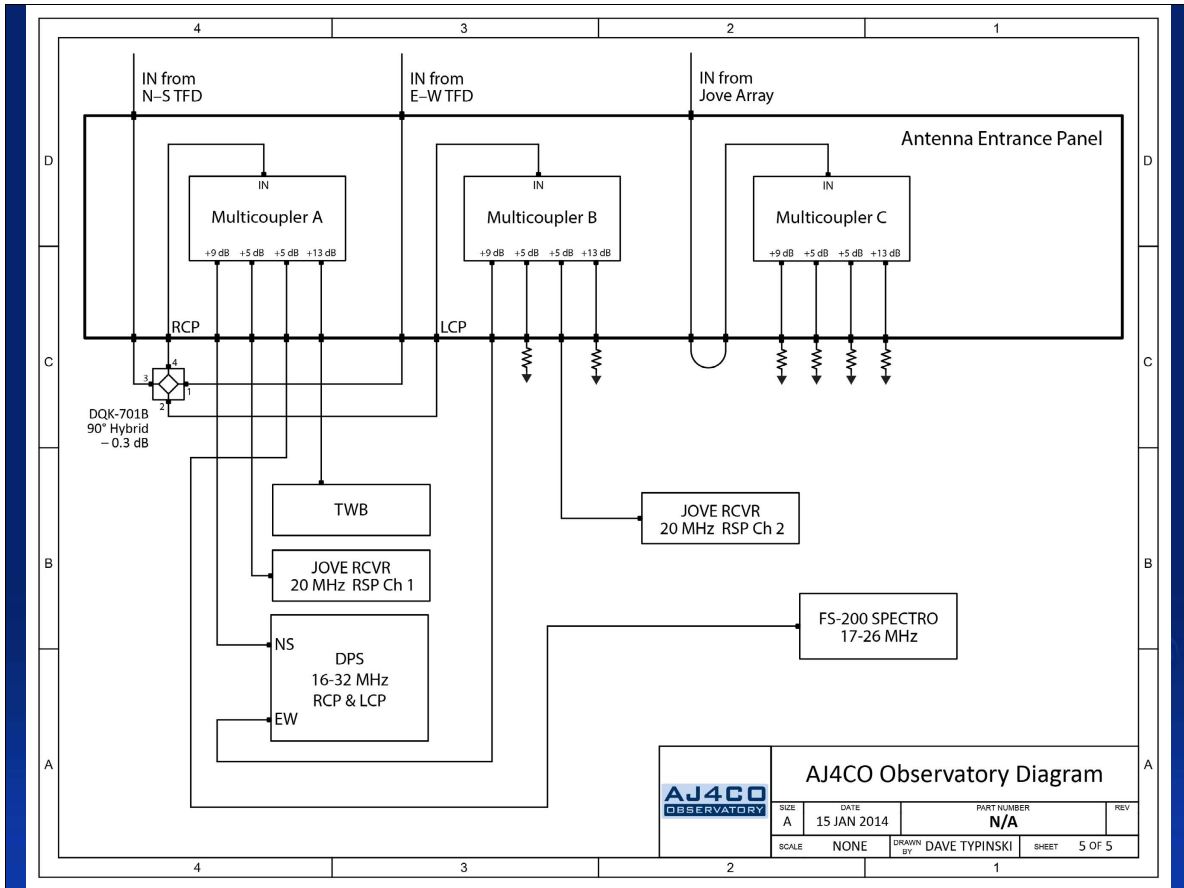

The first “block” of the TWB, the multicoupler, is actually part of the observatory antenna entrance panel.

Shown here is the observatory antenna connection and signal distribution schematic.

RCP and LCP are extracted from the TFD array by means of a Synergy Microwave DQK-701B wideband 90° hybrid before being passed to multicouplers A (RCP) and B (LCP).

The TWB is connected to the +13 dB output port of either MC A for RCP (for Io-A & Io-B observing sessions) or MC B for LCP (for Io-C observing sessions).

# TWB Multicoupler & Observatory Antenna Entrance Panel

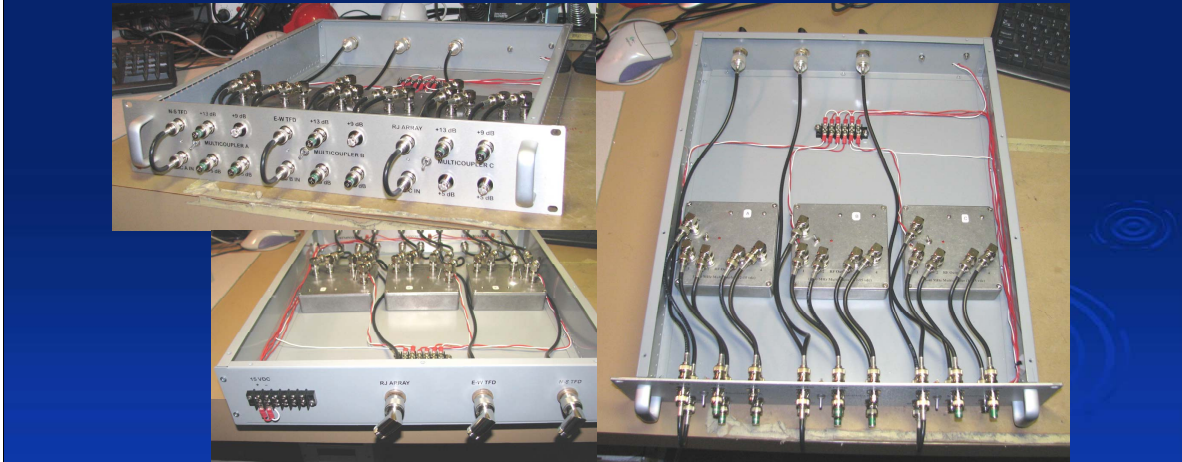
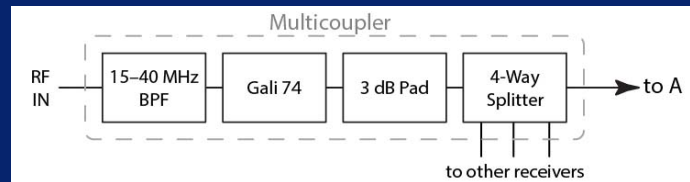

The observatory antenna entrance panel consists of three multicouplers. They were designed & built by Flagg and slightly modified by Typinski to provide different gains at the four output ports. The highest gain port on each MC provides +13 dB; these are the ports used for the TWB system. In this capacity, the multicoupler acts as the front end filter and front end amplifier of the TWB system.

Each multicoupler consists of a 15 to 40 MHz BPF followed by a Gali-74 MMIC amplifier, followed by 3 dB pad, then a 4-way power divider, followed by an attenuator on each port to set the gain at each output port.

# TWB Upconverter & Tuning Blocks

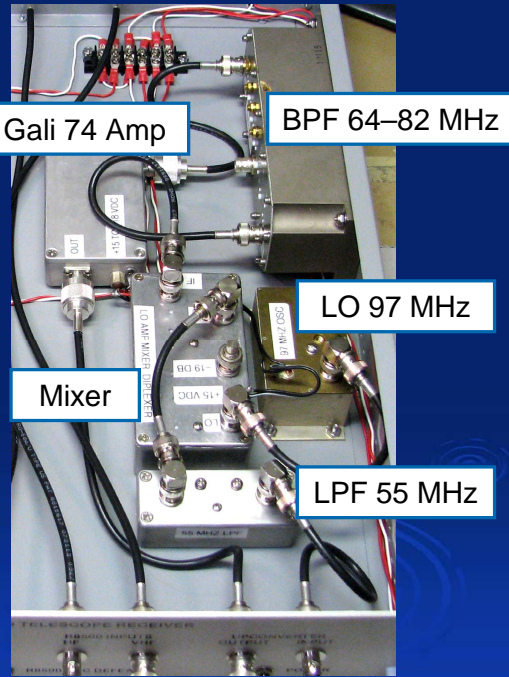
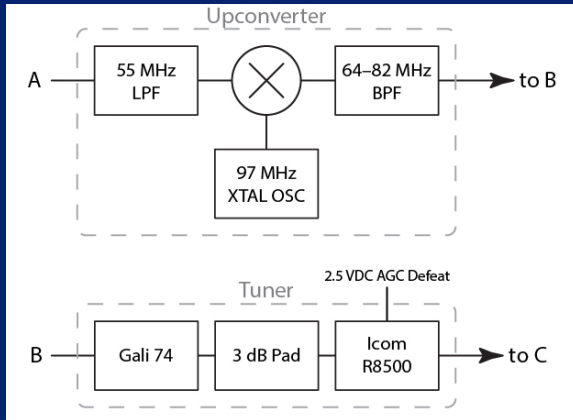

Shown here is the Flagg and Greenman designed and built upconverter section of the TWB.

The signal from the multicoupler runs through a 55 MHz LPF and is mixed with a 97 MHz LO.

The mixer output goes to a 64-82 MHz BPF. It is then amplified and sent to the Icom R8500.

The R8500 is tuned from 65 to 81 MHz to cover a system RF input range from 16 to 32 MHz.

The R8500's 10.7 MHz IF output is sent to the downconverter block.

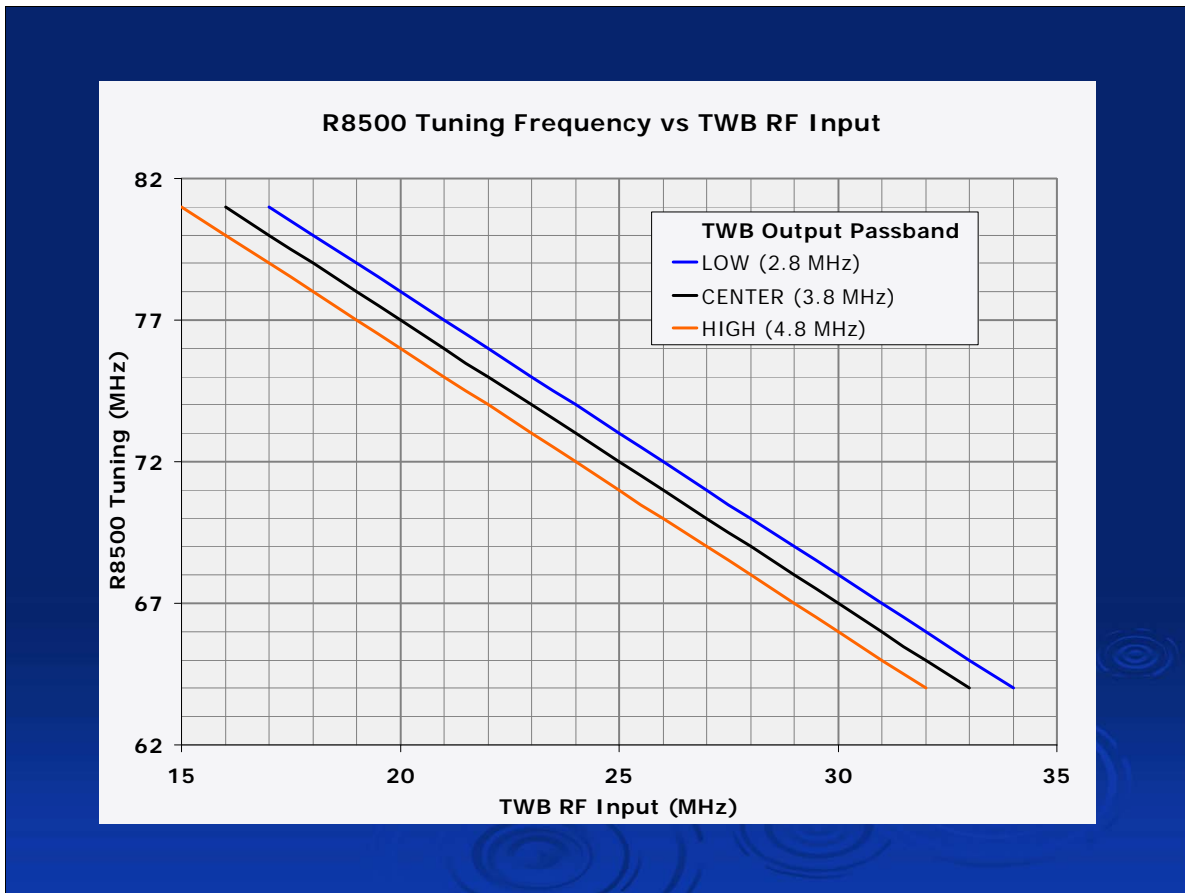

The 8500 looks at the signal after the first conversion to the 64 to 81 MHz range. Since the Icom R8500 acts as the “tuner” for the TWB, we need to know where to tune the 8500 to observe the desired 2 MHz -wide portion of the spectrum.



# TWB Downconverter Block

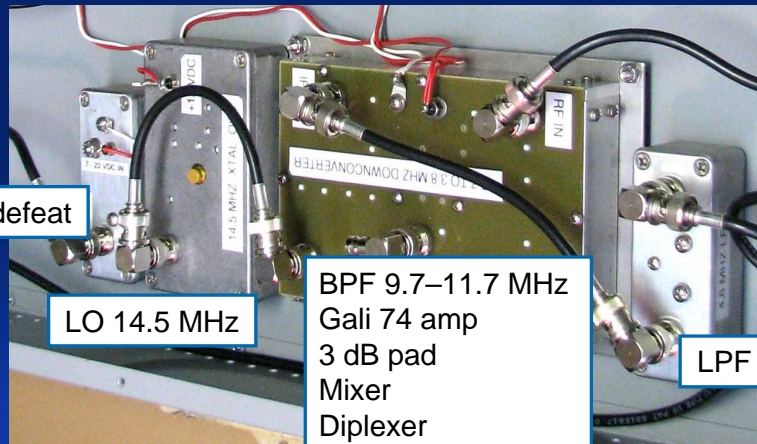
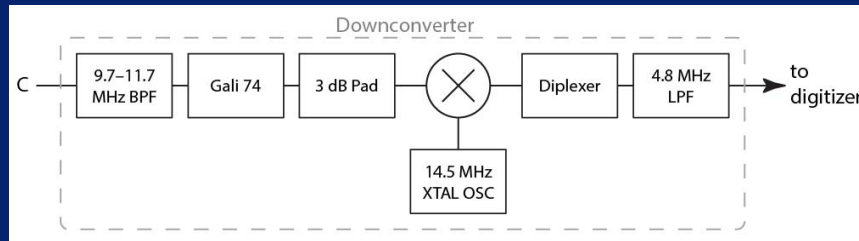

Show here is the Flagg designed and built TWB downconverter.

A 2 MHz wide BPF filters the R8500's IF output (which is actually over 4 MHz wide at the 1 dB points).

The signal is then amplified and mixed with a 14.5 MHz LO to produce an output centered at 3.8 MHz.

The mixer output is passed through a diplexer and then to a 4.8 MHz anti-aliasing LPF prior to the digitizer.

Not shown: after initial testing, slight aliasing with strong signals was evident. Greenman fabbed up a 5 MHz Cauer LPF. With both anti-aliasing filters in series, no more aliases.

# TWB Digitizer

**CompuScope 1220**  
**Versatile waveform digitizer card for PCI bus**



Analog Bandwidth:

Input Range	-3 dB Point
±10 V	5 MHz
±5 V	5 MHz
±2 V	10 MHz
±1 V	10 MHz
±500 mV	10 MHz
±200 mV	10 MHz
±100 mV	10 MHz
±50 mV	10 MHz

Sampling Rates:  
 20 MS/s, 10 MS/s, 5 MS/s, 2 MS/s, 1 MS/s,  
 500 kS/s, 200 kS/s, 100 kS/s, 50 kS/s,  
 20 kS/s, 10 kS/s, 5 kS/s, 2 kS/s, 1 kS/s

The Gage digitizer resides in a relatively garden variety PC running Windows XP. The digitizer is a two-channel device, of which only one channel is used. This doubles the available recording time, since the data from only channel is written to the digitizer’s on-board RAM. The TWB system runs the digitizer at 10 Msamp/sec on a ±50 mV range. Many thanks go to Dr Higgins for loaning us this digitizer.

The CompuScope 1220 card is of 2005 vintage.

---

# The TWB Mark III Calibration

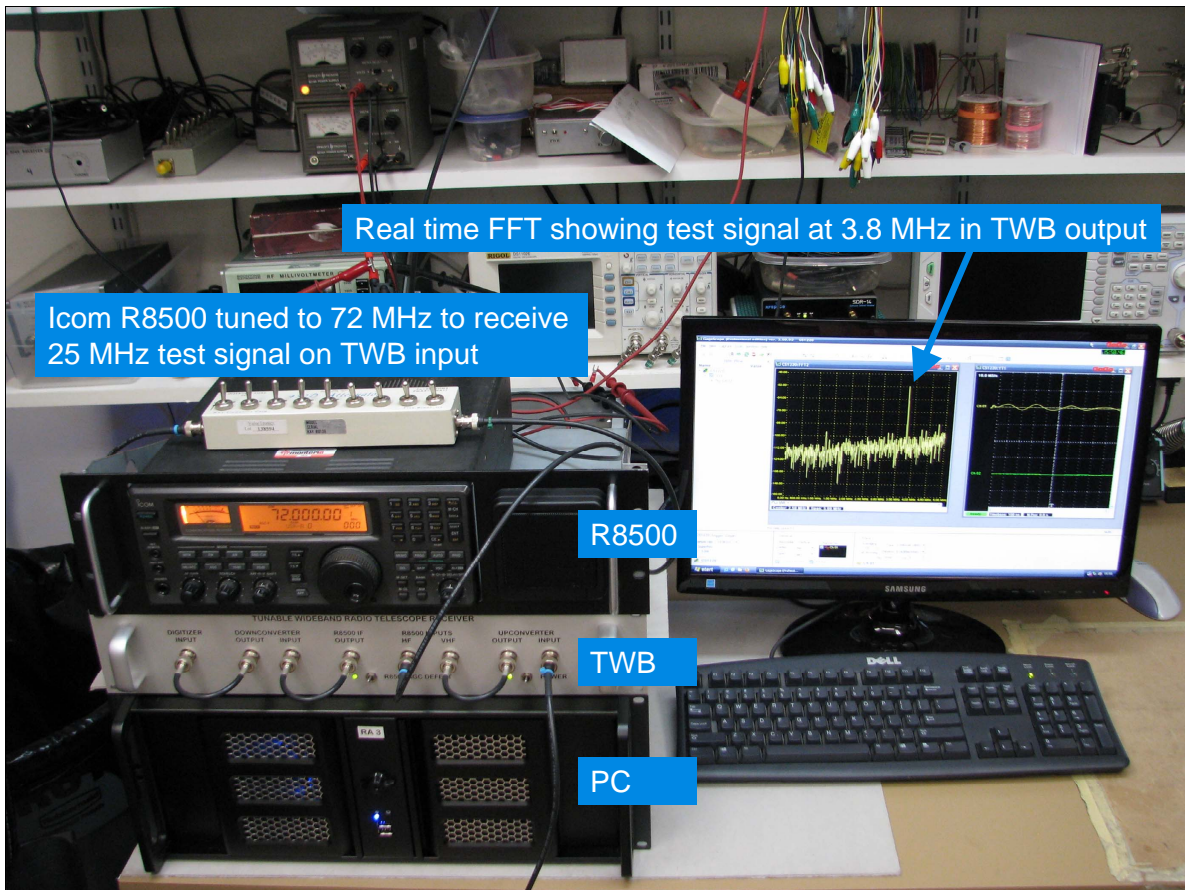

### Frequency Calibration (more of a verification, really)

TWB integrated system bench check

R8500

TWB receiver

PC with digitizer hardware and software

PC is running the GageScope software, showing a spike in the FFT output at the center of the TWB's output IF passband at 3.8 MHz.

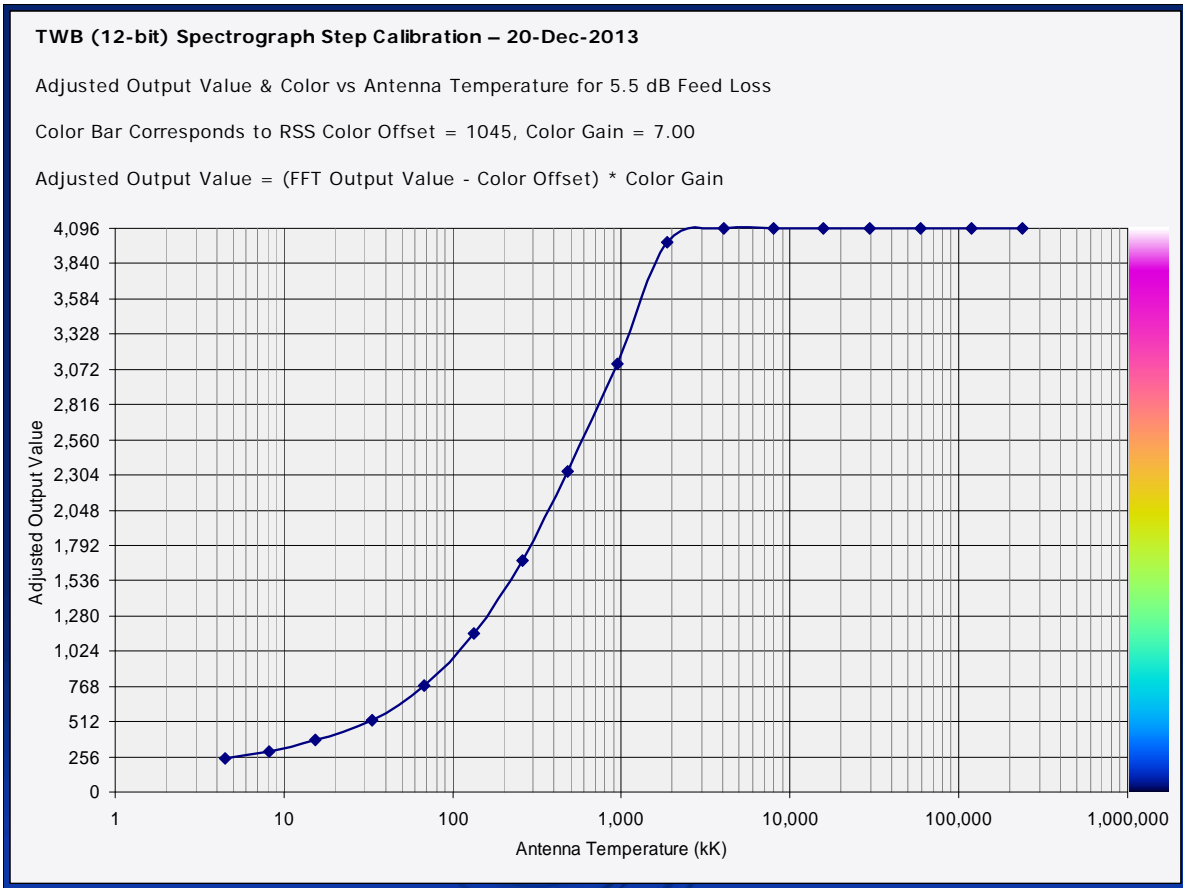

### Power Calibration

The RSS color gain and offset are configured for a roughly 20 dB dynamic range for Jupiter. The hardware will support a 40 dB dynamic range.

Calibration was performed by using a high temperature noise source of known output power and a step attenuator (Kay 432D), running through 17 3 dB steps. Same setup as in previous photo, but with an HP 461 noise source (calibrated against a 5722 noise gen) in lieu of the HP 8648 signal generator.

---

# The TWB Mark III Software

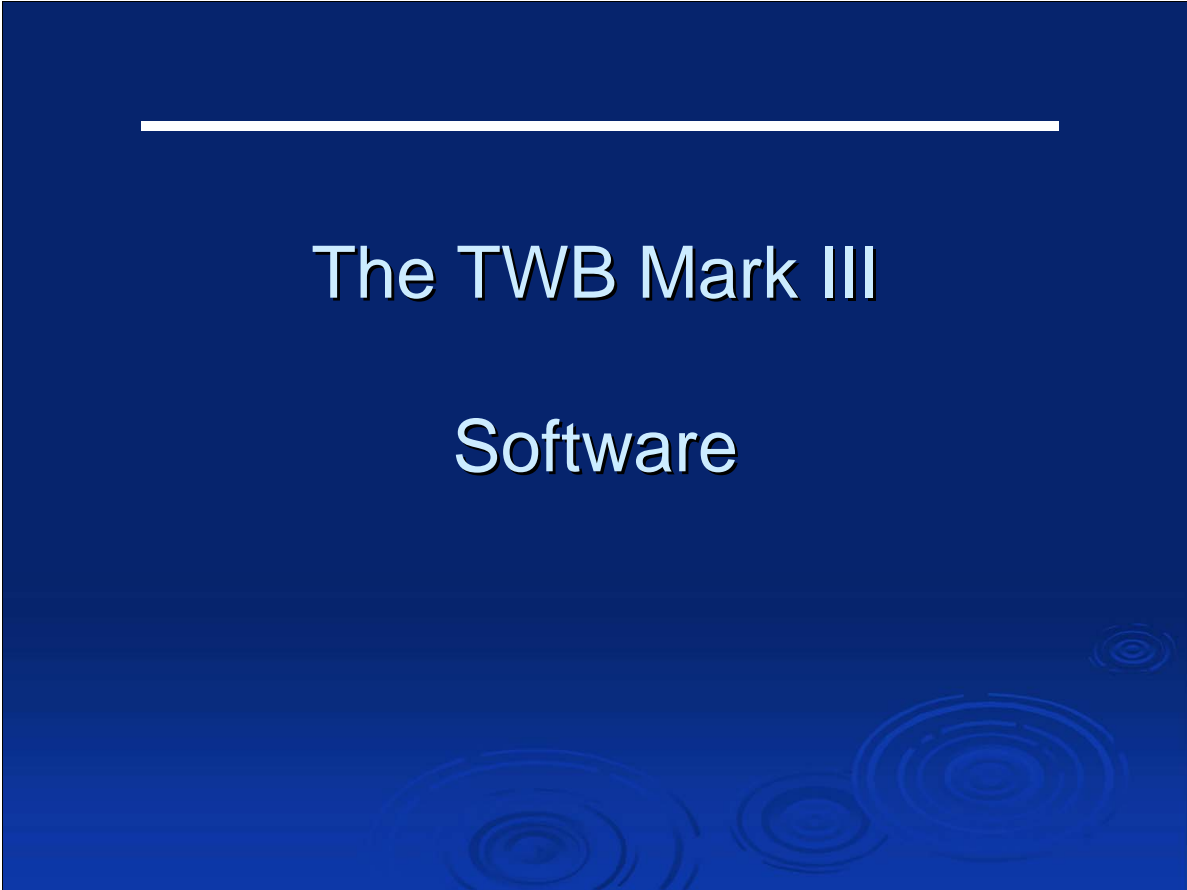

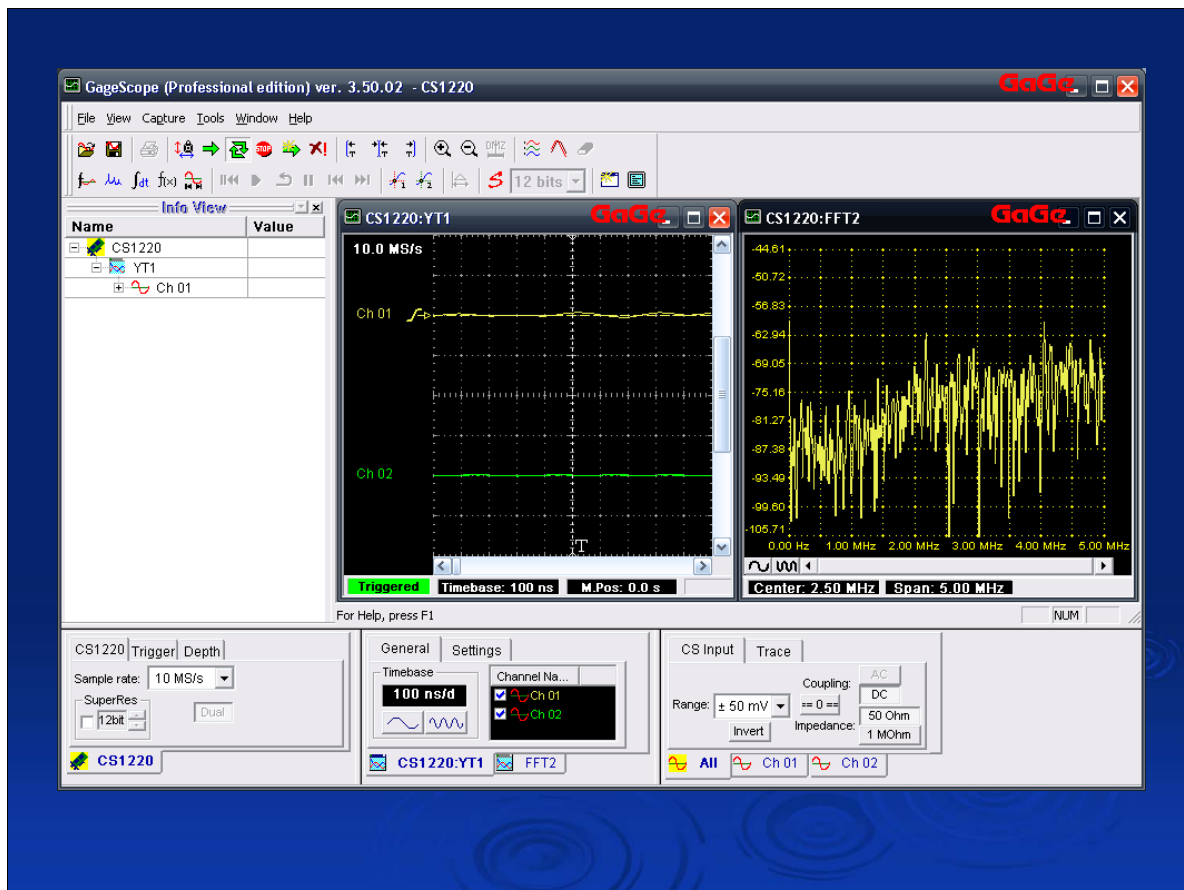

This is the user interface of the GageScope software. This software configures and operates the digitizer hardware, pulling data from the digitizer's RAM and writing it to a file on the PC's hard drive.

On the left is the two-channel scope display (the card is two-channel, but the TWB only uses one). On the right is the real time FFT showing the TWB output from 0 to 5 MHz.

Even though the digitizer can only record for 210 msec at a time, the software can be configured to command the digitizer to make multiple recordings back-to-back, with minimal "dead-time" between each recording. The "dead-time" is the time it takes the software to transfer the signal data from RAM to disk.

# TWB FFT Processing

## ➤ Processing performed in Mathematica

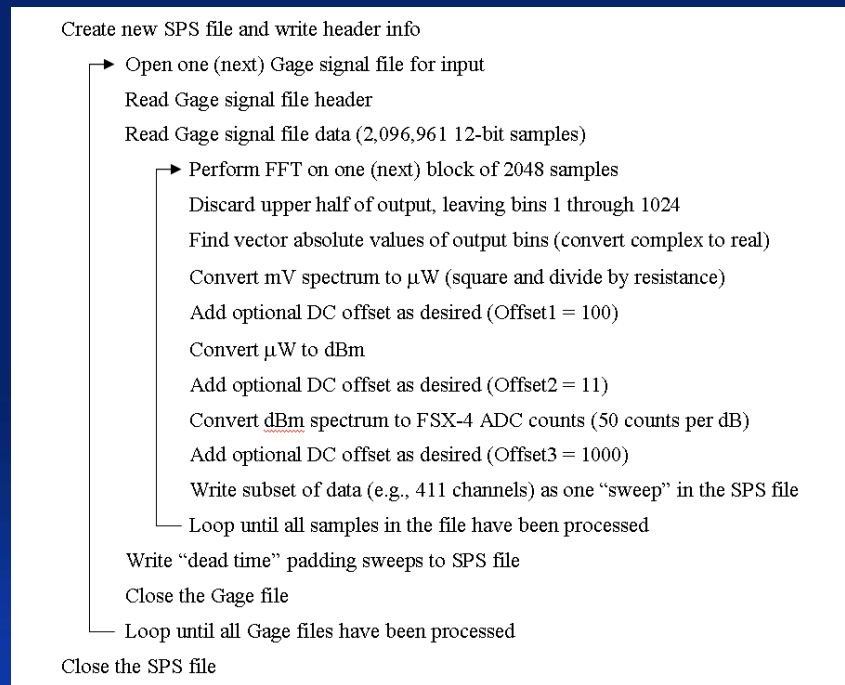

The Gage digitizer can only record about 210 msec of data at a time. It can do this repeatedly, but there is a “dead time” of about 180 msec while the Gage software writes the contents of its RAM to the hard drive. We tell the software to records 153 of these “data bursts” in rapid succession. This covers one minute of observing.

The digitizer writes its time-series data points to a file on disk, two bytes for every data point. The goal is to convert the Gage time-series data into a frequency domain format we can work with. We have done so using a Mathematica routine that converts all 153 data files for a 1-minute observation into a single SPS file. The outline shown here describes the processing, all of which takes place in Mathematica.

The SPS file can then be manipulated by RSS in review mode, to do drift rate analysis and to save spectrogram images. Many thanks go to Jim Sky for adding several features in RSS to handle the high speed data – such as putting milliseconds on the timestamps on the x axis of the waterfall displays.

The Gage time series data is first processed by an FFT using an FFT block of 2,048. The FFT output is converted from voltage to power, and then a conversion from power to the equivalent output of a log detector is made. The FSX spectrographs use log detectors, and we emulate the FSX-4.

Offsets 1 through 3 exist to help get the visual dynamic range into some useful colors in the spectrograms. The values shown here work fairly well.

A more thorough write-up of the TWB data processing is available on the SUG web site.

[http://www.radiojove.org/SUG/Pubs/TWB Data Processing Description v4 \(FGT, 2013\).pdf](http://www.radiojove.org/SUG/Pubs/TWB%20Data%20Processing%20Description%20v4%20(FGT,%202013).pdf)

The next slide show a simpler representation.



# TWB FFT Processing

$$SPS_i = \text{ADC counts per dB} \left[ 10 \log \left( \frac{|FFT_i|^2 + \text{Offset1}}{R} \right) + \text{Offset2} \right] + \text{Offset3}$$

$$SPS_i = 50 \left[ 10 \log \left( \frac{|FFT_i|^2 + 100}{50} \right) + 11 \right] + 1000$$

This is the mathematics of the TWB processing, to get the time domain data from Gage signal file format to the frequency domain SPS format readable by RSS. The subscript  $i$  represents the  $i$ th element of each FFT output being converted to the  $i$ th element of the SPS data file frequency sweep.

The conversion from microwatts to milliwatts exists because the Gage digitizer records voltages in millivolts, not volts. Millivolts squared gets you microwatts – but you need milliwatts for the subsequent conversion to dBm.

The values for the offsets were determined by comparing the log detector response and post-detector, pre-ADC DC amp offset in the FSX-4 so that the TWB's post-FFT output would be similar to the FSX-4's output.

# TWB Digital Audio Processing

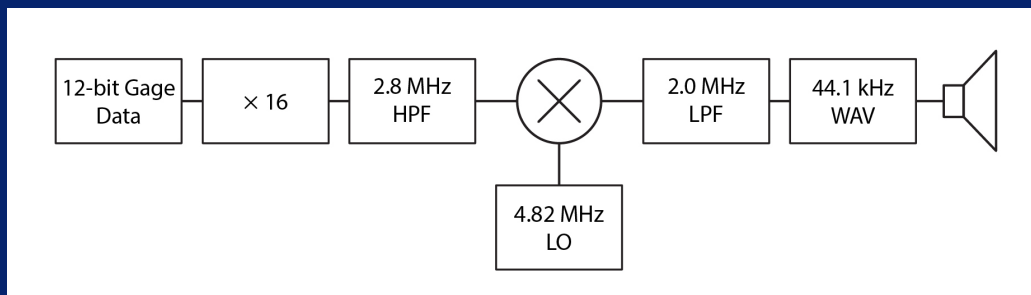

- All processing performed digitally in Mathematica
- 10 Msamp/sec RF played at 44.1 ksamp/sec
- 227 X slowdown (~ 8 octaves)
- 25–27 MHz RF expanded to 88 Hz – 8.9 kHz AF
- 210 msec of RF stretched to 48 sec of audio

The TWB audio is created after the data has been digitized.

- 1) The 12-bit Gage signal data is multiplied by 16 to convert it to 16-bit data.
- 2) The signal data is passed through a 2.8 MHz high pass filter to remove the high-frequency RF components that lie above the desired band (remember, the TWB output passband is inverted).
- 3) The signal is mixed with a 4.82 MHz LO, high side injection to mirror the passband, thus de-inverting the output. This has the effect of taking the 4.8 to 2.8 MHz inverted TWB IF output (the Gage signal data file) and downconverting it to the 0.02 to 2.02 MHz band.
- 4) The signal is then passed through a 2.0 MHz LPF to remove unwanted high freq components. The sample rate is still 10 Msamp/sec, but we only want the signals that lies in the 0 to 2.02 MHz band.
- 5) After being suitably processed in steps 1 through 4, the 10 Msamp/sec time series signal data is then written as a WAV file. The header of the WAV file indicates the data is to be played back at a rate of 44.1 ksamp/sec (44.1 kHz). This has the effect of time-stretching the data upon playback, in turn reducing the bandwidth by a factor of 227. This comes from 10 Msamp/sec (original sample rate) divided by 44.1 ksamp/sec (playback rate) = 226.76. Thus, a Gage RF data file lasting 210 msec will take about 48 seconds to play back as an audio file.

NOTE: Since the original sample rate is 10 Msamp/sec, the original bandwidth is 5 MHz. The WAV file reduces this by a factor of 227, to 22 kHz.

HOWEVER: the Jovian signals only lie from 0.02 MHz to 2.02 MHz of the processed data, so they cover a range of frequencies in the WAV file from 88 Hz to 8.9 kHz. This is good, for while cats can hear audio up to 80(!) kHz, the response curve of human hearing starts to fall off around 10 kHz and is around 10 dB down at 16 kHz (your mileage may vary).

---

# The TWB Mark III Observations





TWB installed in a 19" rack. AJ4CO Observatory, High Springs, Florida.

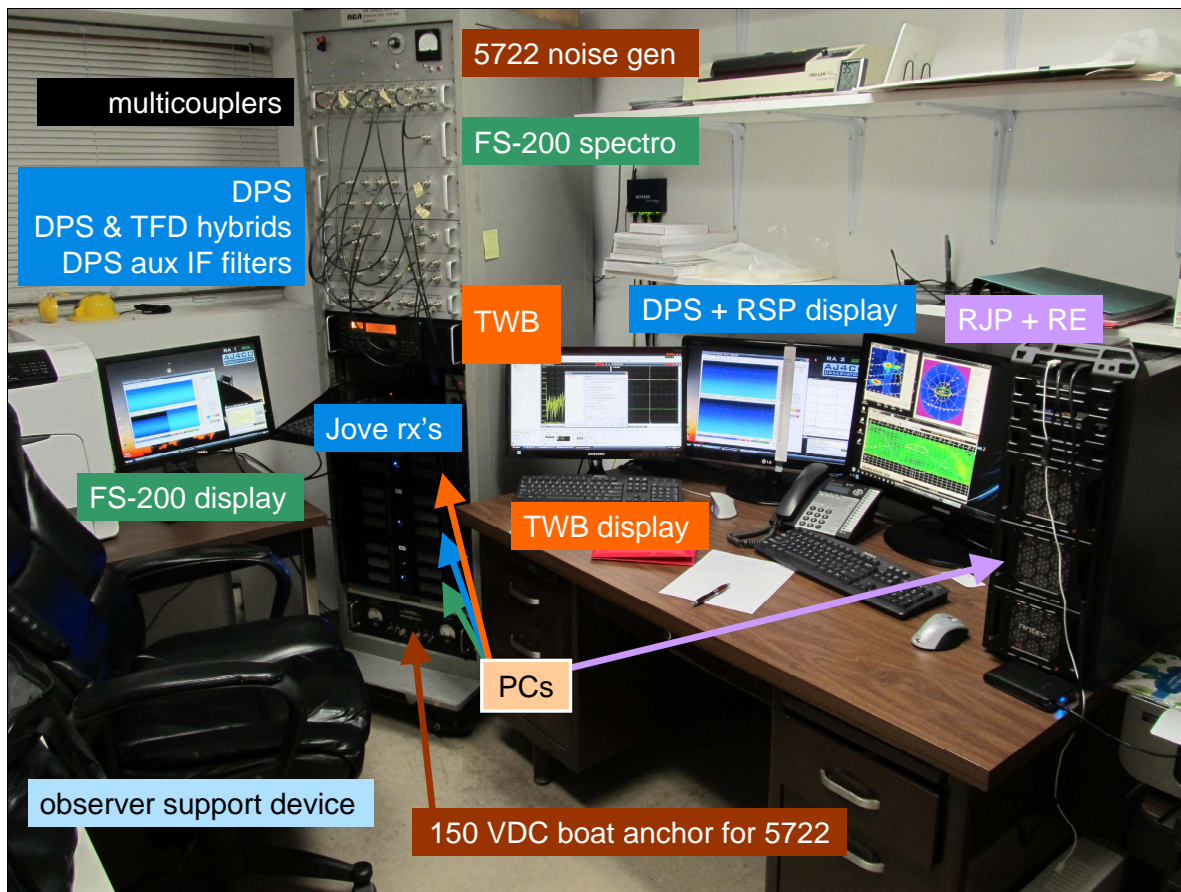

TWB installed in a 19" rack. AJ4CO Observatory, High Springs, Florida.

TWB system component labels in orange.

The wide bandwidth displays from the DPS were used to determine where to tune the TWB – in other words, to determine what 2 MHz slice of spectrum to look at with the high speed digitizer. In this way, we could chase S bursts, SN events, and N events as they changed in frequency.

The R8500's audio was connected to a speaker, but since the AM demodulation mode on the 8500 is relatively narrow (12 kHz max at the center of the 2 MHz BW being digitized), this was of little help.

Likewise, the GageScope software's real-time FFT display was of similarly little to no use; the FFT is only 1024 points, three times per second, so the continuum display was far too noisy to see much of anything except across-the-board spikes from nearby lightning.

# WWV Frequency Check

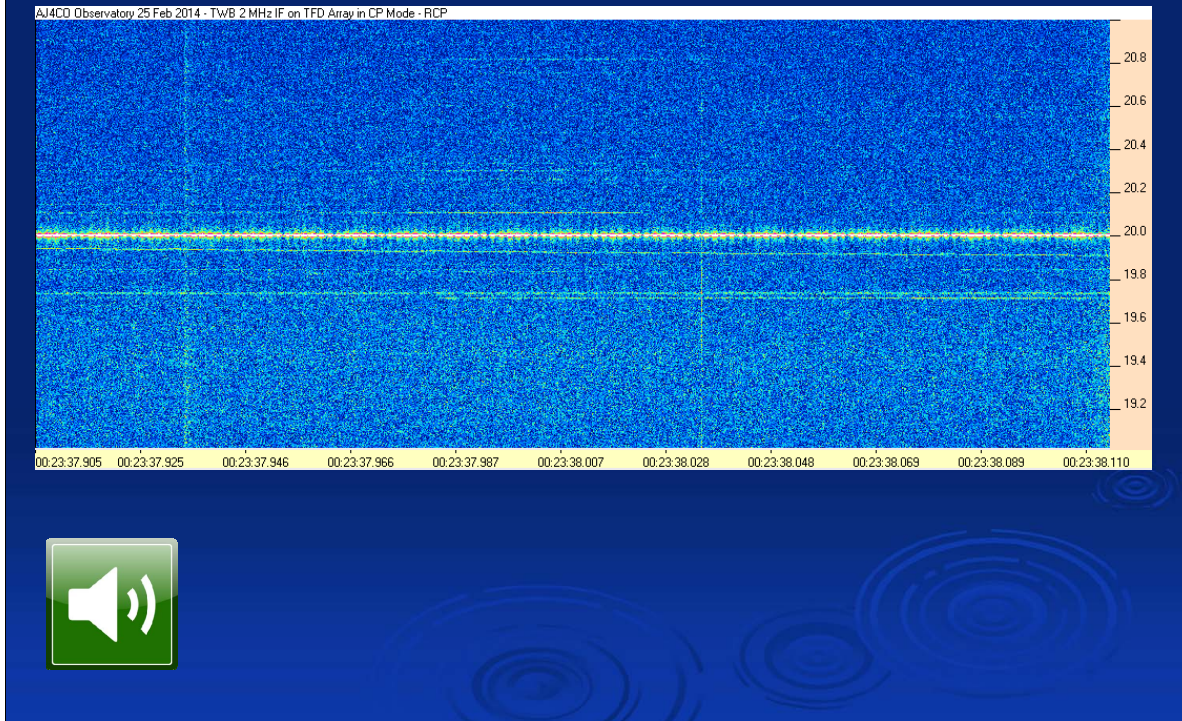

WWV showing 20.00 MHz center frequency – verifying that all the RF hardware and software processing is not shifting the signal frequency.

Also visible is the 100 Hz BCD time code subcarrier (21 envelopes across the spectrogram) and a 440 Hz audio tone on top of that (the smaller envelopes, each 4 to 5 pixels wide).

# TWB Observations 2013–14 Apparition

- 19 Jupiter observing sessions, Nov–Mar
  - 11 good storms w/ digitized data
  - 3 no-shows (no S bursting or N events)
  - 5 washed out with line noise
  
- Data collected & processed: ~ ½ TB

Let's take a look at some examples of what we were able to observe

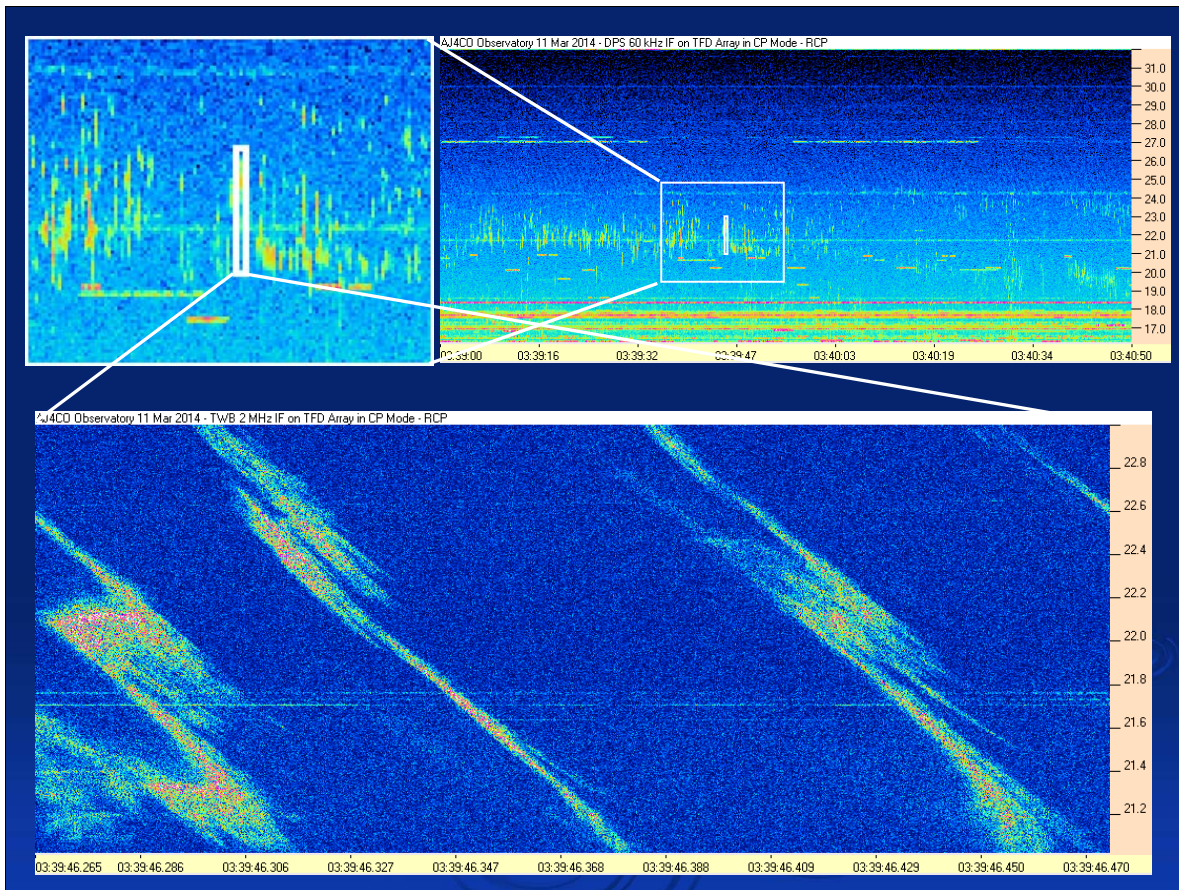

A comparison of a typical FSX waterfall (this one from the DPS) versus the TWB high speed data waterfall. This is intended to provide a sense of the time scale represented in the spectrograms on the following slides.

The DPS spectrogram, upper right, covers 110 seconds in 700 pixels, or about 157 millisecond per sweep (sweep rate of a little over 6 sweeps per second).

The upper left image is just a blown-up view of the DPS spectrogram, so we can see the small inner rectangle. **This rectangle contains spectrogram data 1 pixel in width and about 40 pixels in height.**

The lower spectrogram is the TWB data taken at the same time, covering 210 milliseconds and 2 MHz, (1,023 pixels by 411 pixels).

TWB Spectrogram	DPS Spectrogram
210 millisecond window	110 second window
2 MHz of spectrum	16 MHz of spectrum
411 channels	300 channels
205 microsecond per FFT	157 millisecond per sweep
4.88 kHz RBW	60 kHz IF BW (slight overlap of channels)



---

Observations

S bursts

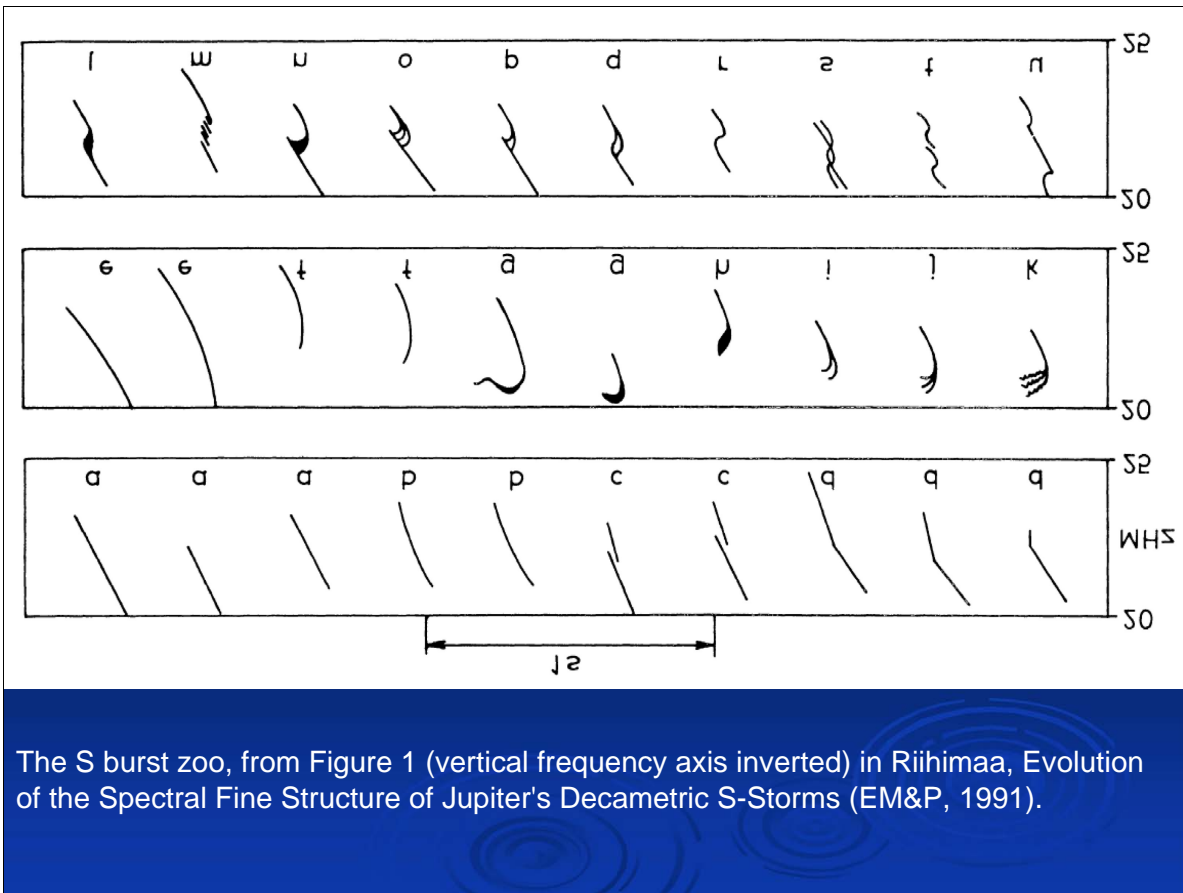

The S burst zoo, from Figure 1 (vertical frequency axis inverted) in Riihimaa, Evolution of the Spectral Fine Structure of Jupiter's Decametric S-Storms (EM&P, 1991).

Riikimaa reported a wide variety of S burst morphologies. His spectrograms were plotted with the low frequency at the top, so we invert his image here for better comparison with spectrograms that plot the high frequency at the top.

# TWB Observations – S bursts

29 Dec 2013, Io-C, LCP

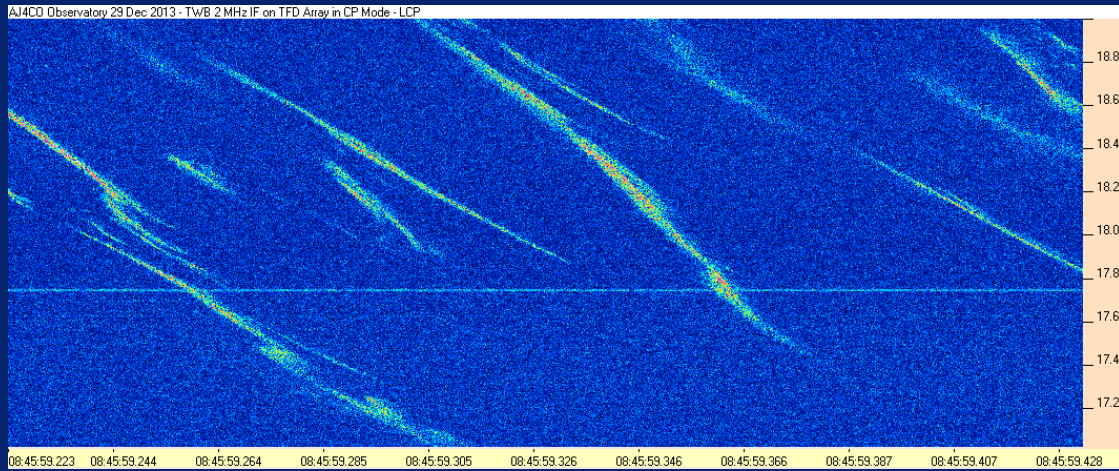

- -15 MHz/s for true S
- -26 MHz/s features
- 210 msec window
- 2 MHz of spectrum
- 205  $\mu$ s per FFT
- 4.88 kHz RBW

# TWB Observations – S bursts

29 Dec 2013, Io-C, LCP

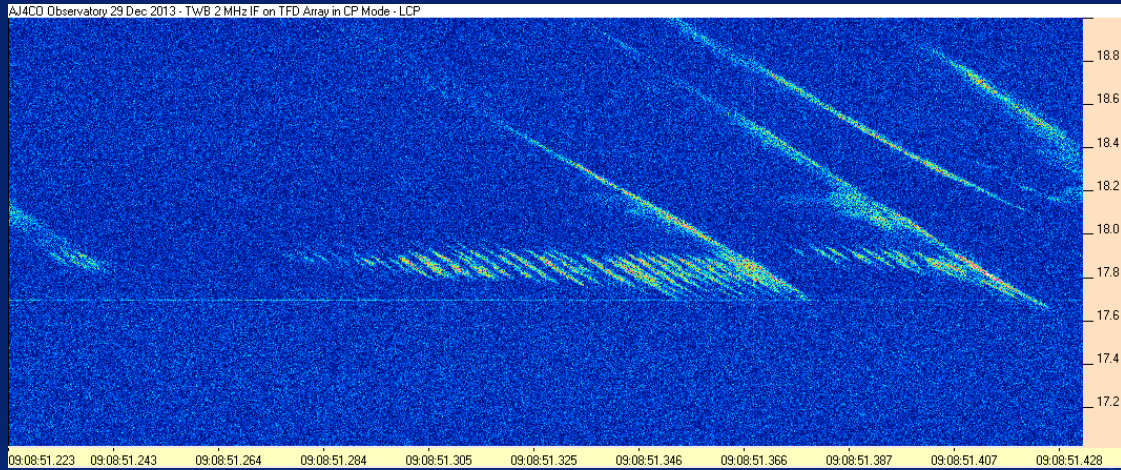

➤ -15 MHz/s

➤ SN + S

# TWB Observations – S bursts

29 Dec 2013, Io-C, LCP

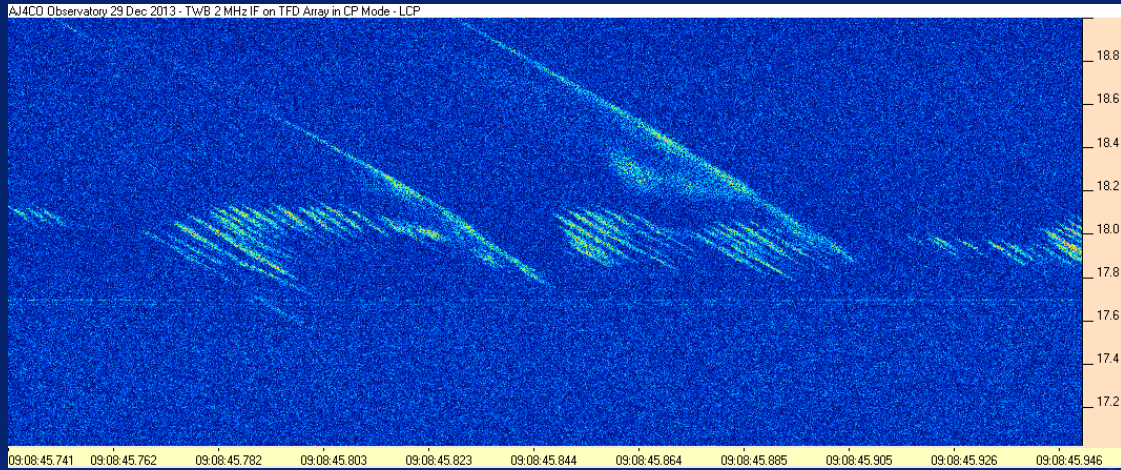

➤ -15 MHz/s

➤ SN + S

# TWB Observations – S bursts

29 Dec 2013, Io-C, LCP

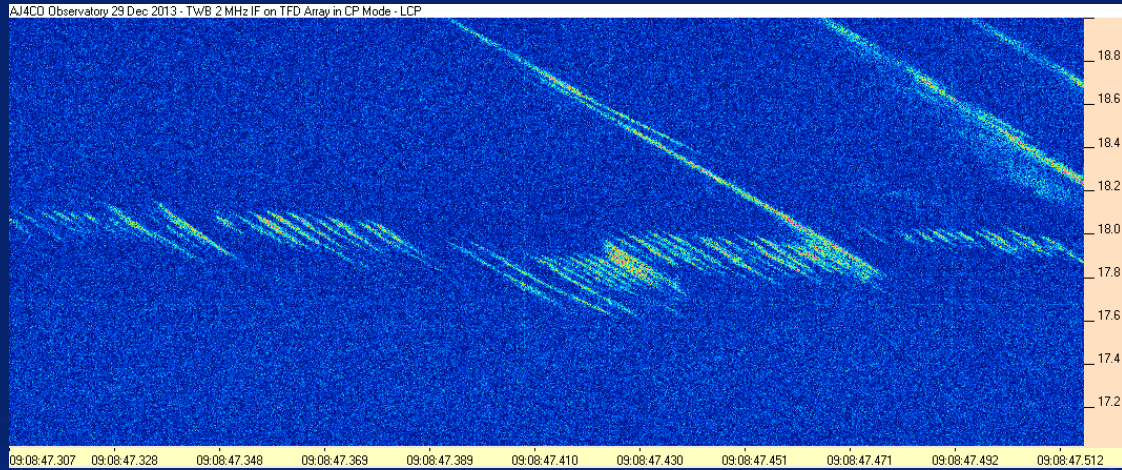

➤  $-15 \text{ MHz/s}$

➤ SN + S

# TWB Observations – S bursts

29 Dec 2013, Io-C, LCP

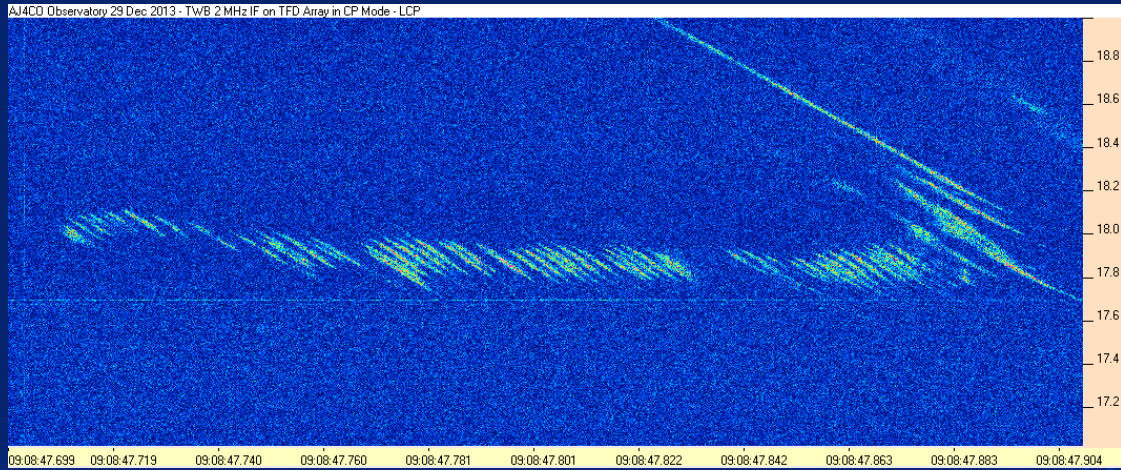

- -15 MHz/s
- SN + S

# TWB Observations – S bursts

29 Dec 2013, Io-C, LCP

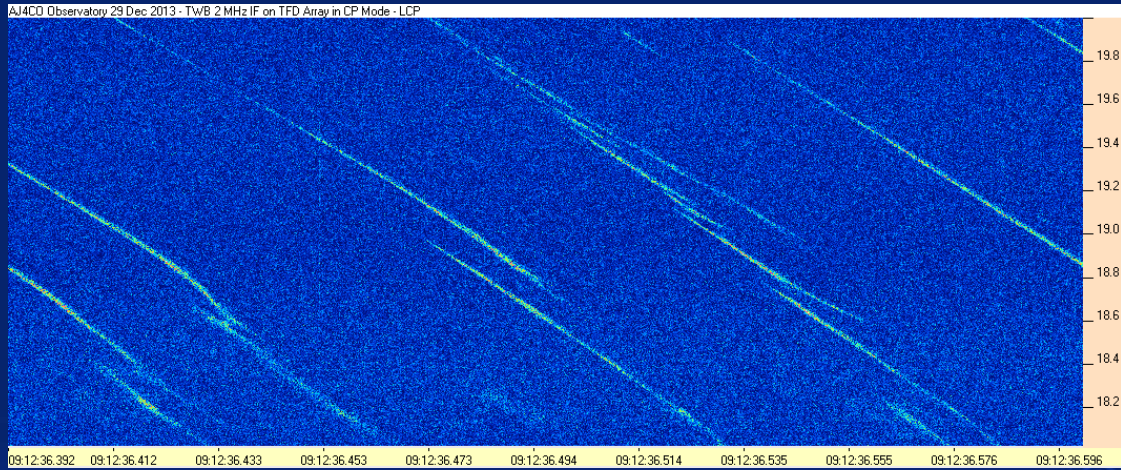

➤ -16 MHz/s

➤ “pure” S



# TWB Observations – S bursts

29 Dec 2013, Io-C, LCP

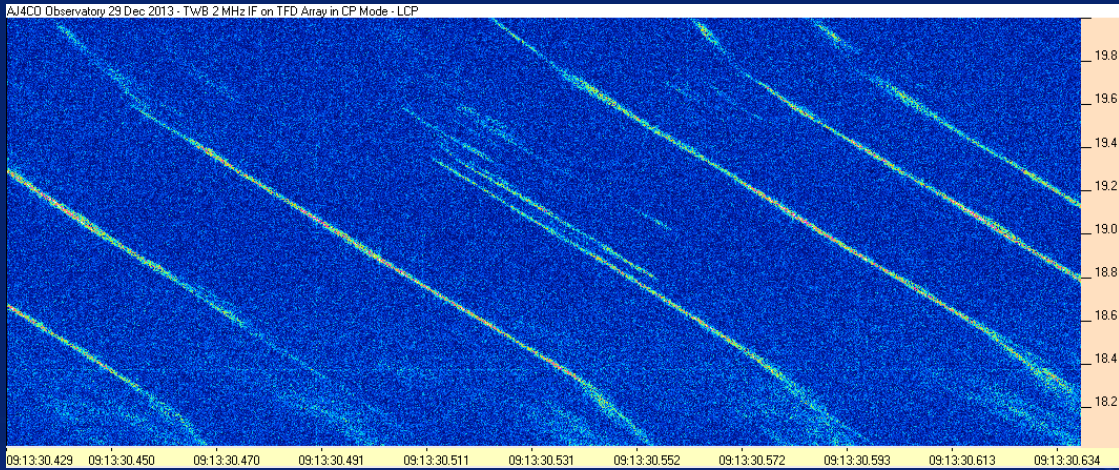

- -16 MHz/s
- “pure” S

# TWB Observations – S bursts

29 Dec 2013, Io-C, LCP

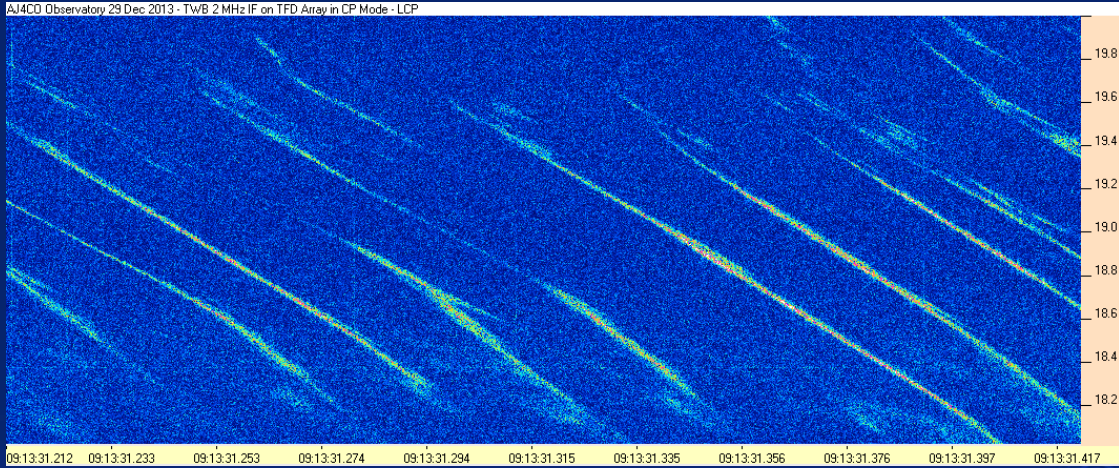

- -15 MHz/s
- “pure” S

# TWB Observations – S bursts

30 Jan 2014, Io-C, LCP

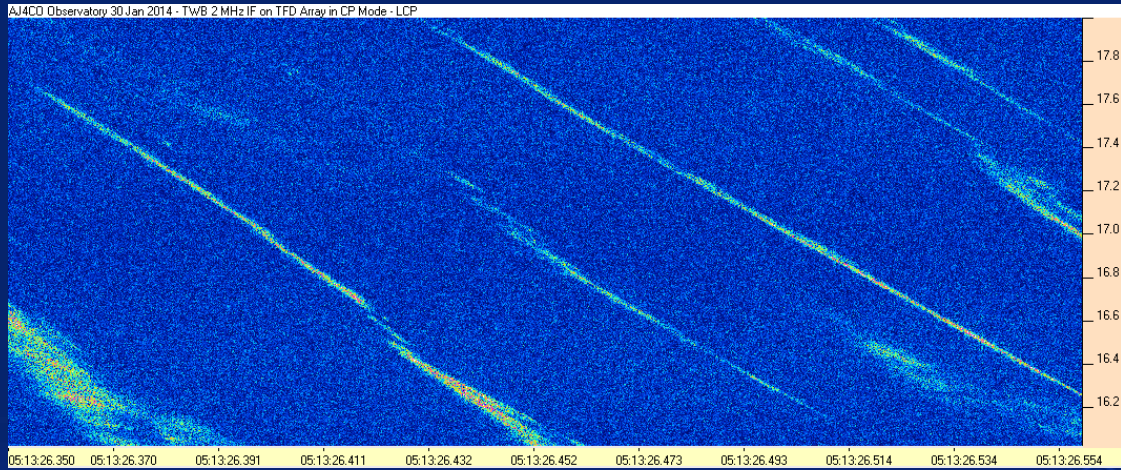

➤ -17 MHz/s

# TWB Observations – S bursts

30 Jan 2014, Io-C, LCP

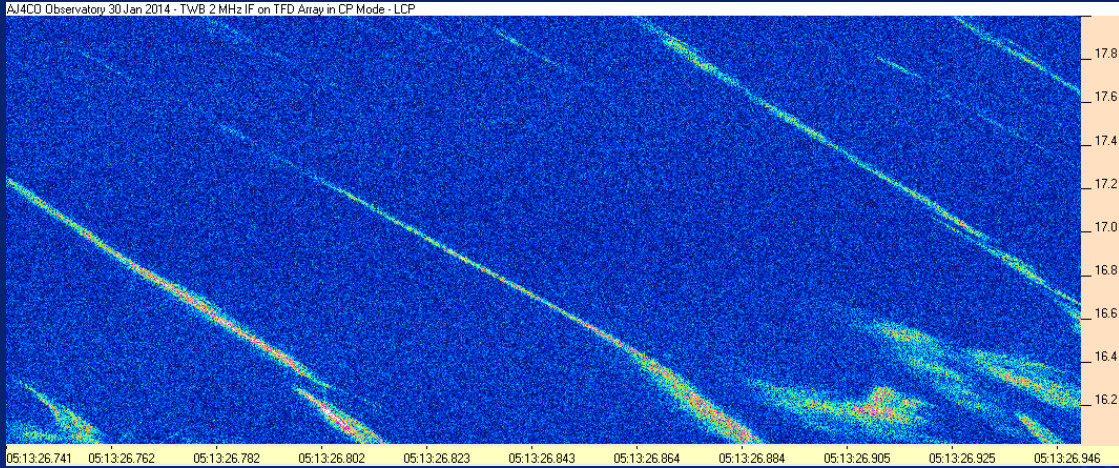

➤  $-17 \text{ MHz/s}$  &  $-13 \text{ MHz/s}$

# TWB Observations – S bursts

30 Jan 2014, Io-C, LCP

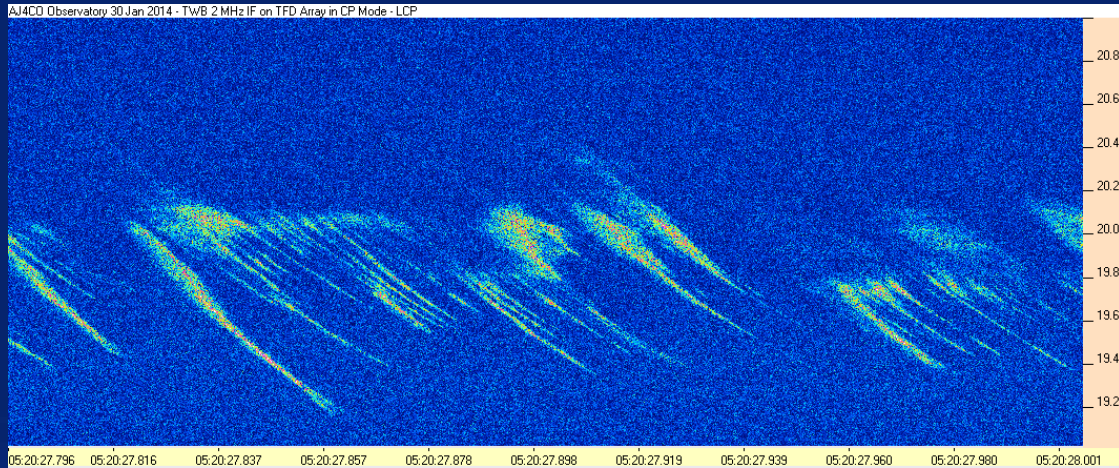

➤  $-17$  MHz/s

➤ poorly organized SN event?

# TWB Observations – S bursts

04 Mar 2014, Io-B, RCP

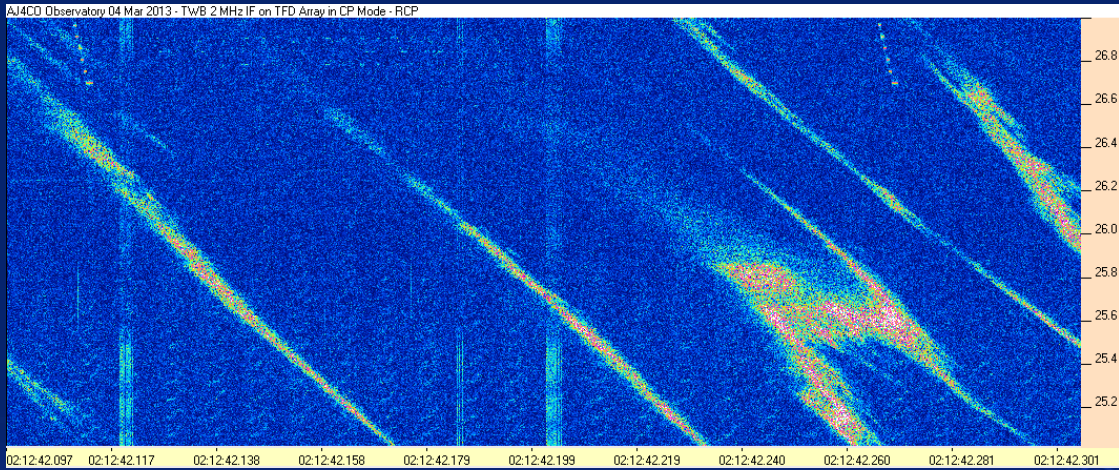

➤ -23 MHz/s

# TWB Observations – S bursts

04 Mar 2014, Io-B, RCP

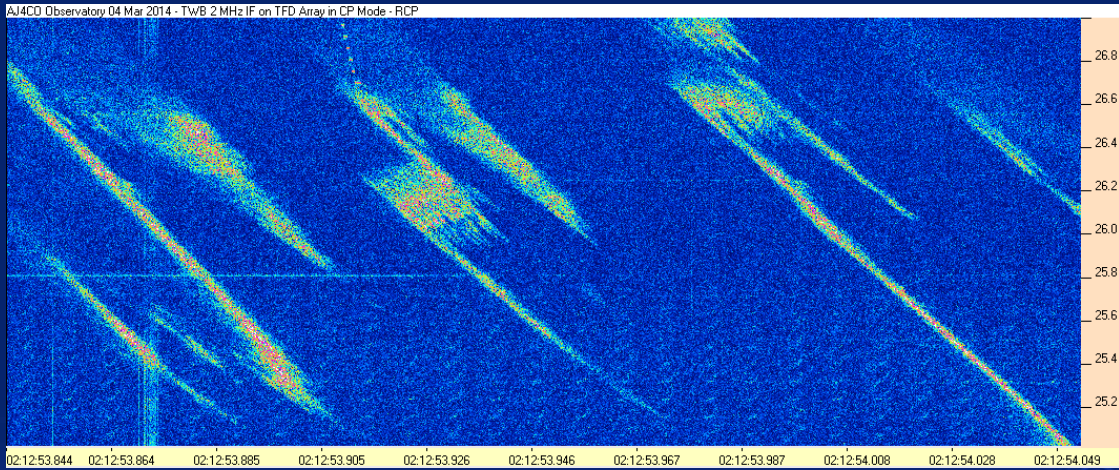

➤  $-20$  &  $-25$  MHz/s

# TWB Observations – S bursts

04 Mar 2014, Io-B, RCP

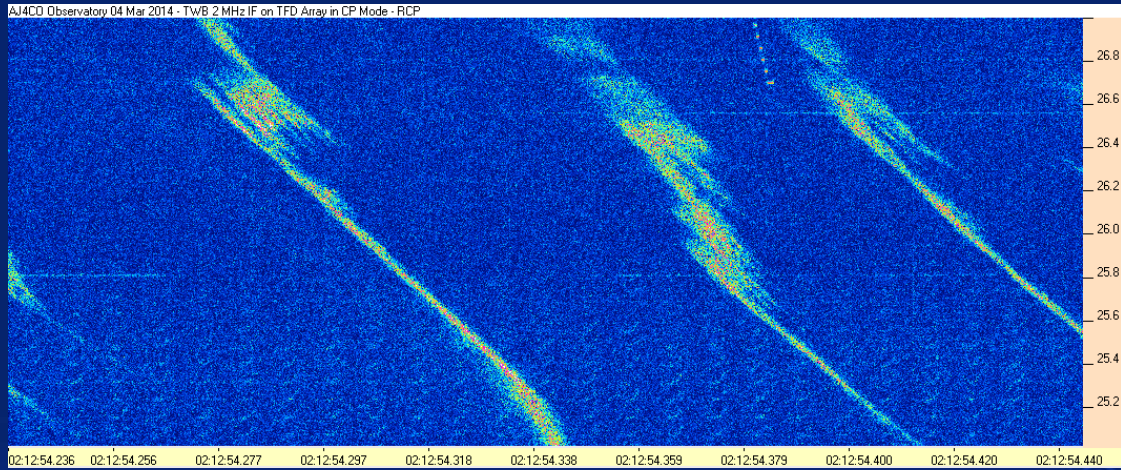

➤ -23 MHz/s



# TWB Observations – S bursts

11 Mar 2014, Io-B, RCP

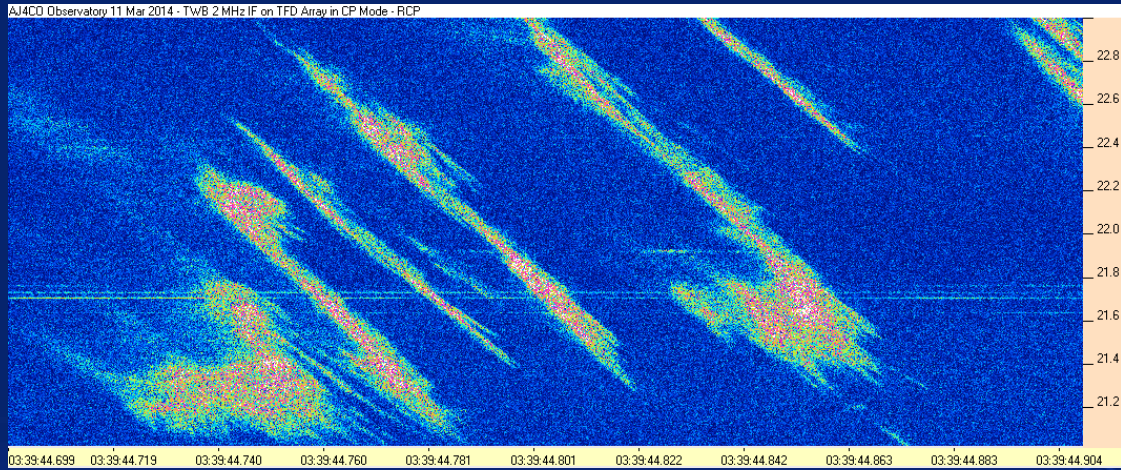

➤ -22 MHz/s

# TWB Observations – S bursts

11 Mar 2014, lo-B, RCP

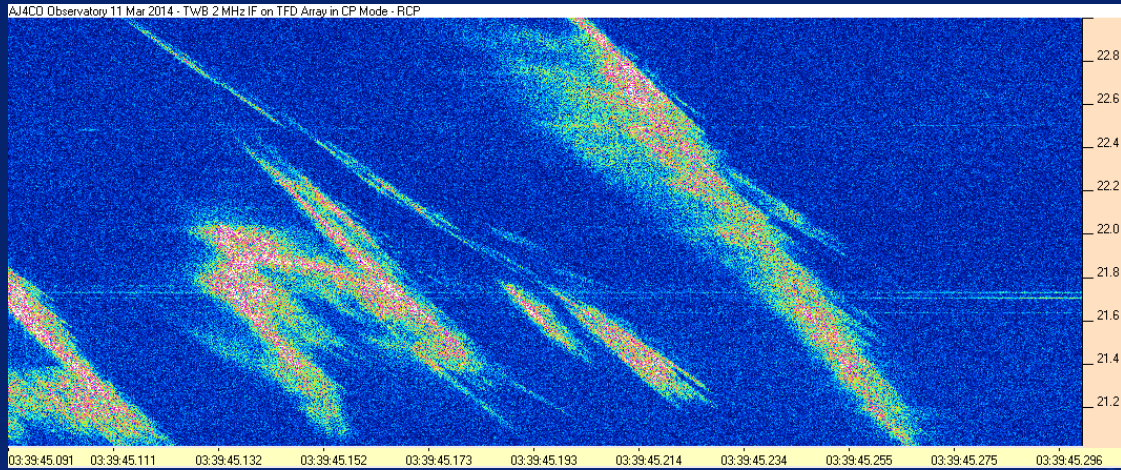

➤  $-22$  &  $-16$  MHz/s

# TWB Observations – S bursts

11 Mar 2014, lo-B, RCP

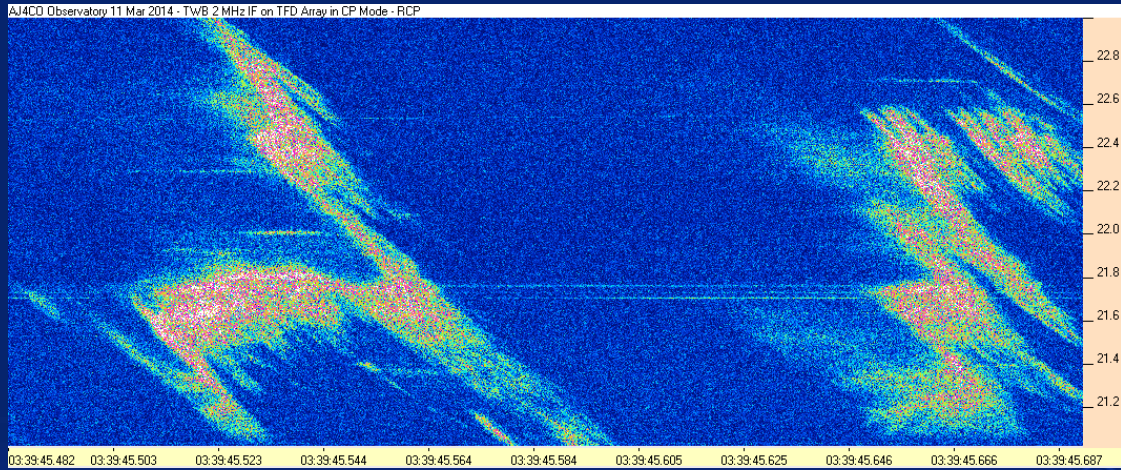

➤ -21 MHz/s

# TWB Observations – S bursts

11 Mar 2014, lo-B, RCP

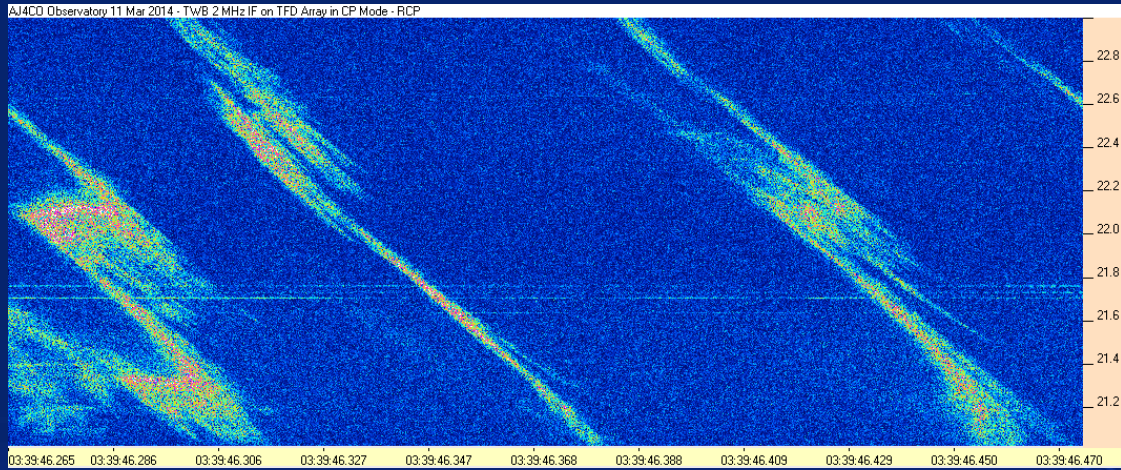

➤ -21 MHz/s

# TWB Observations – S bursts

11 Mar 2014, Io-B, RCP

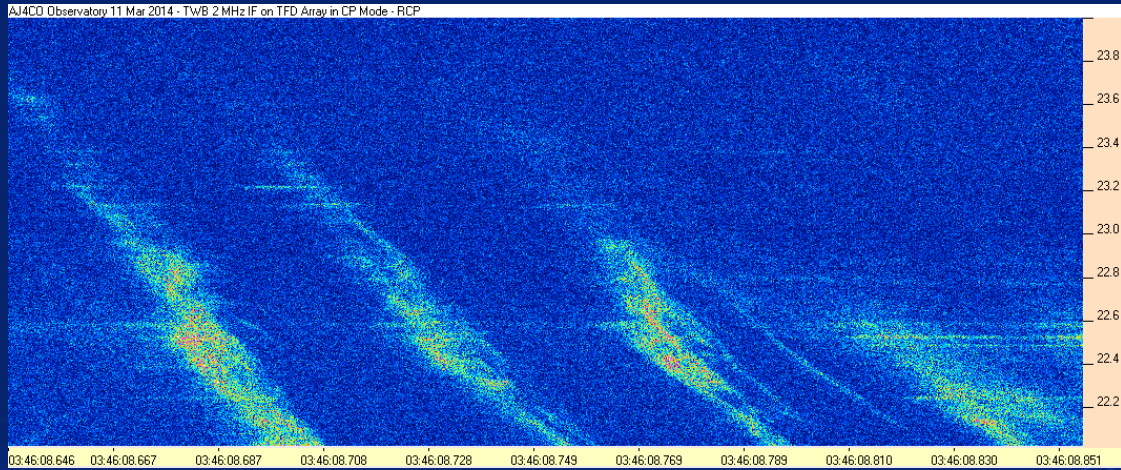

- -25 MHz/s
- notably disorganized

---

Observations

N events

# TWB Observations – N event

23 Dec 2013, Io-B , RCP

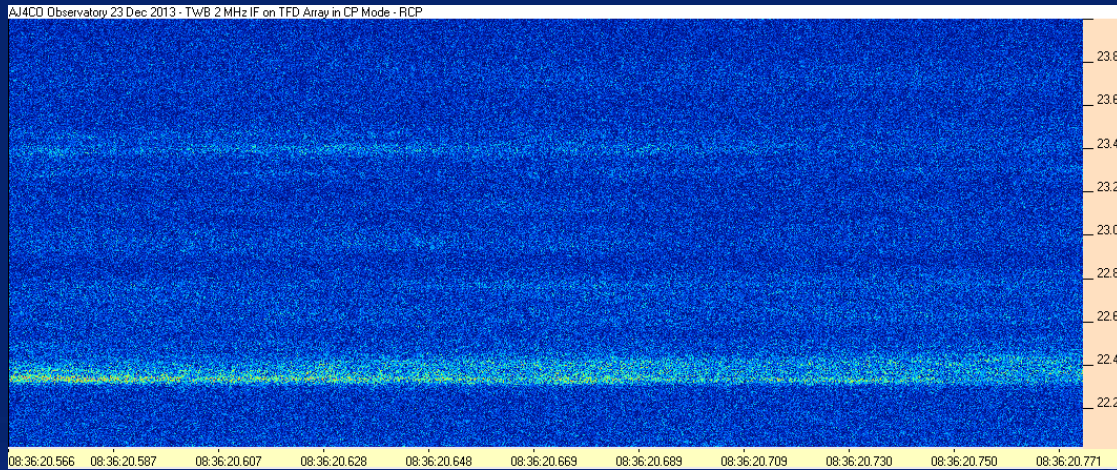

➤ ~ 100 kHz BW

# TWB Observations – N event

23 Dec 2013, Io-B , RCP

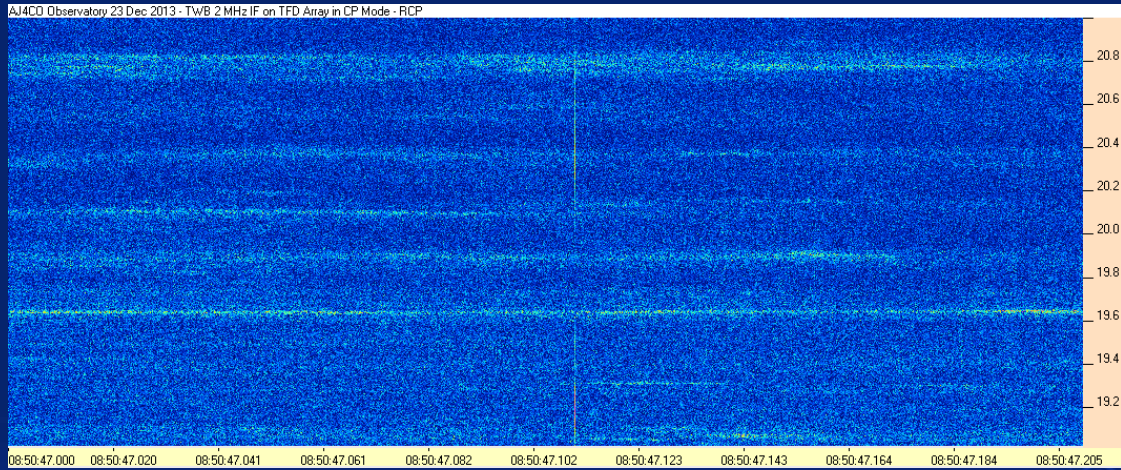

➤ ~ 20 kHz BW



# TWB Observations – N event

23 Dec 2013, Io-B, RCP

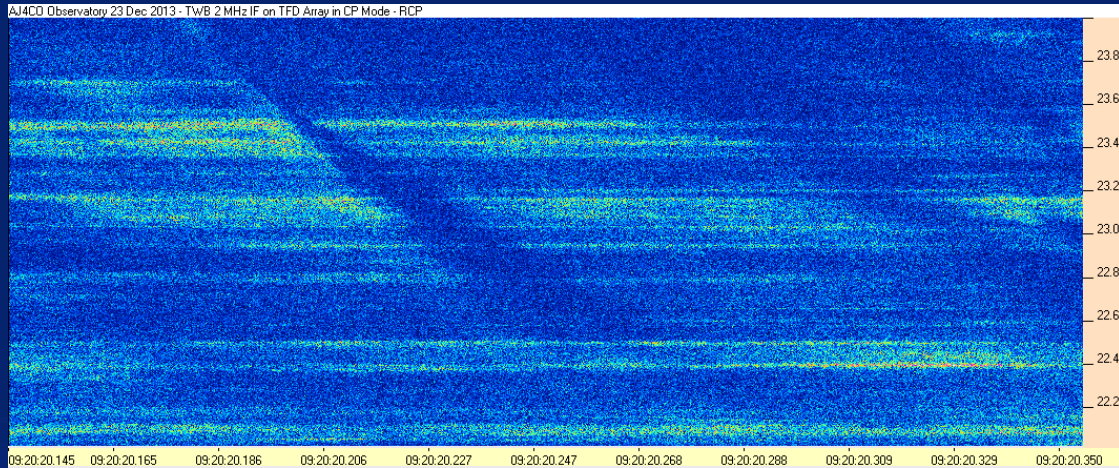

- Several narrow BW's
- FDS event,  $-22$  MHz/s to  $-15$  MHz/s

# TWB Observations – N event

29 Dec 2013, Io-C, LCP

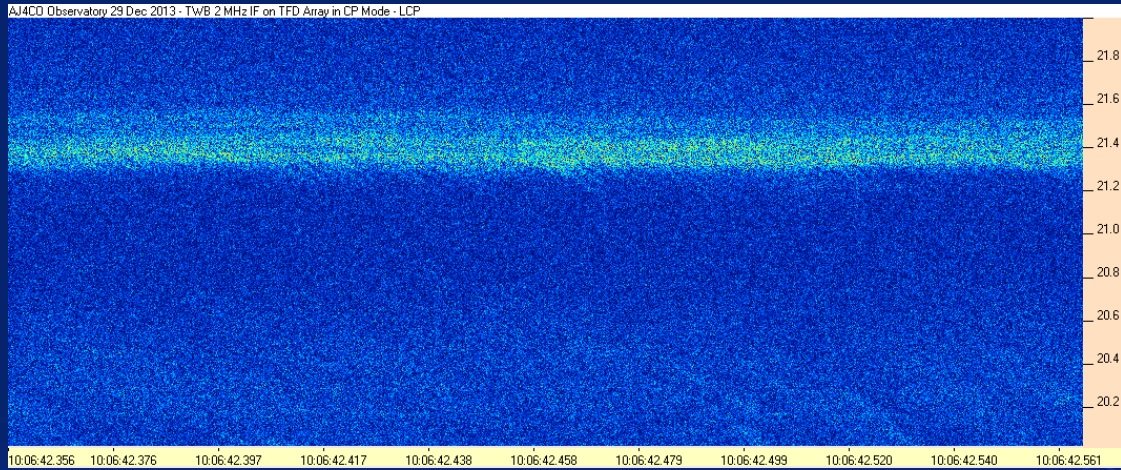

- ~ 250 kHz BW
- Pure N

# TWB Observations – N event

30 Dec 2013, Io-B, RCP

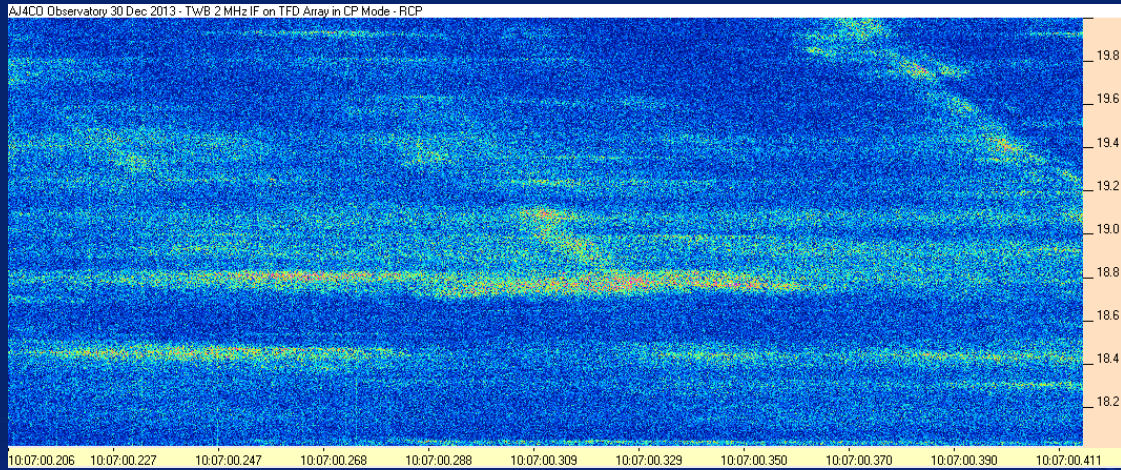

➤ -17 MHz/s features

# TWB Observations – N event

30 Jan 2014, Io-C, LCP

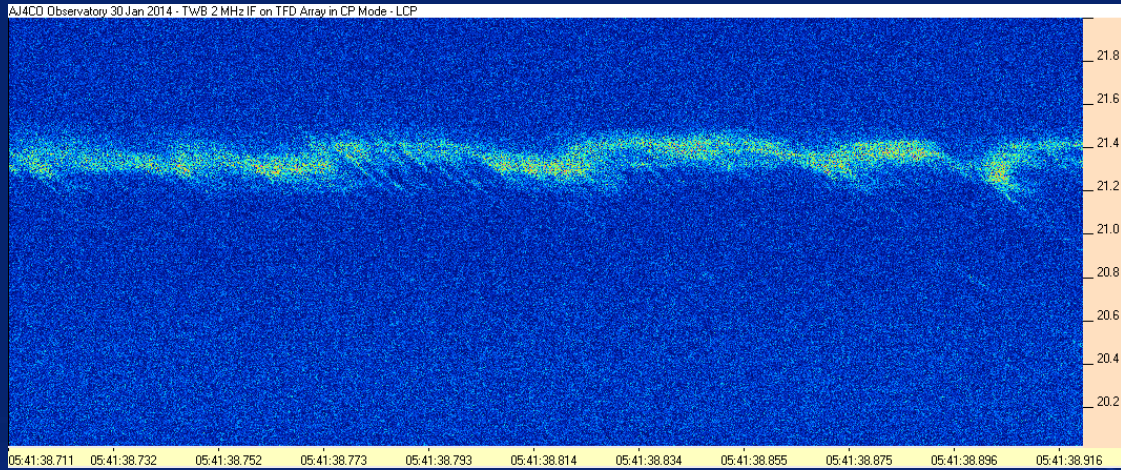

➤ -22 MHz/s features

# TWB Observations – N event

30 Jan 2014, Io-C, LCP

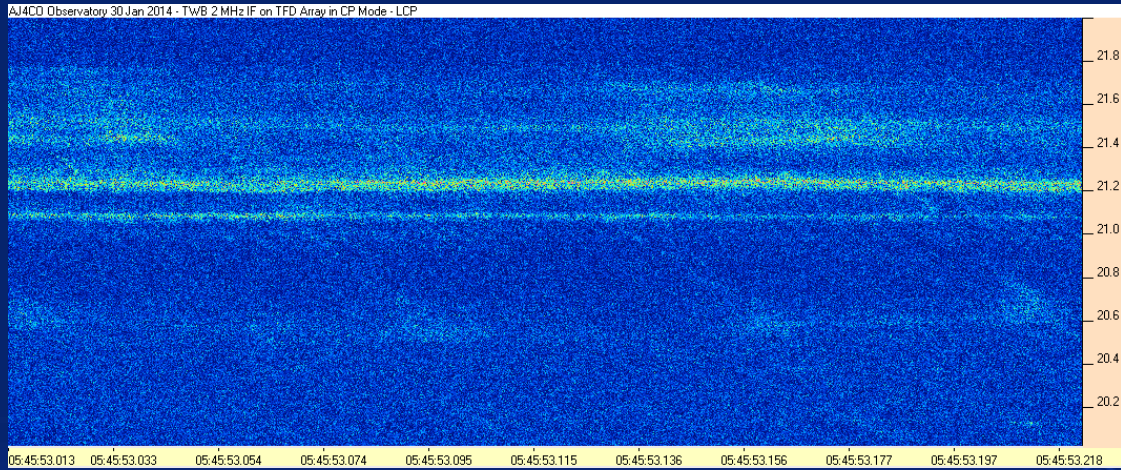

➤ -23 MHz/s features

# TWB Observations – N event

30 Jan 2014, Io-C, LCP

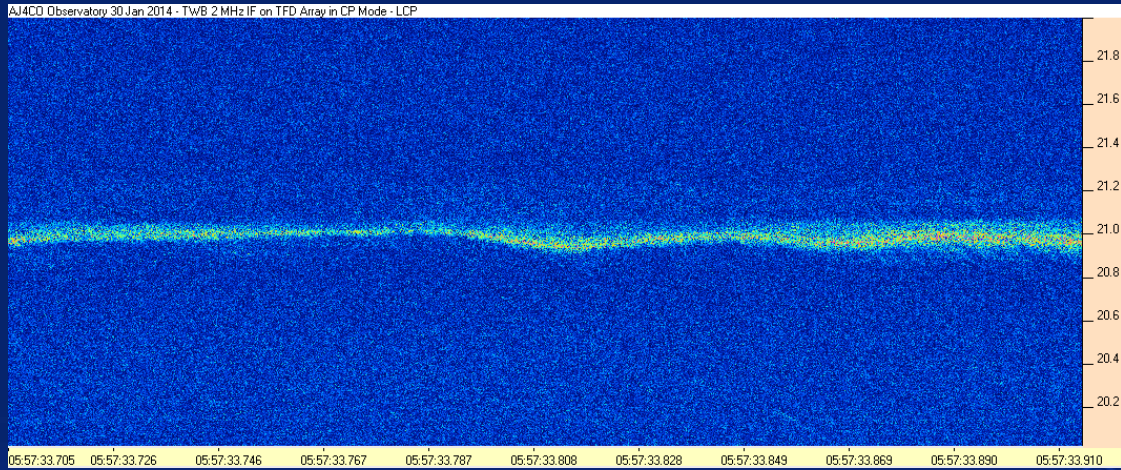

➤ 25–100 kHz BW

# TWB Observations – N event

30 Jan 2014, Io-C, LCP

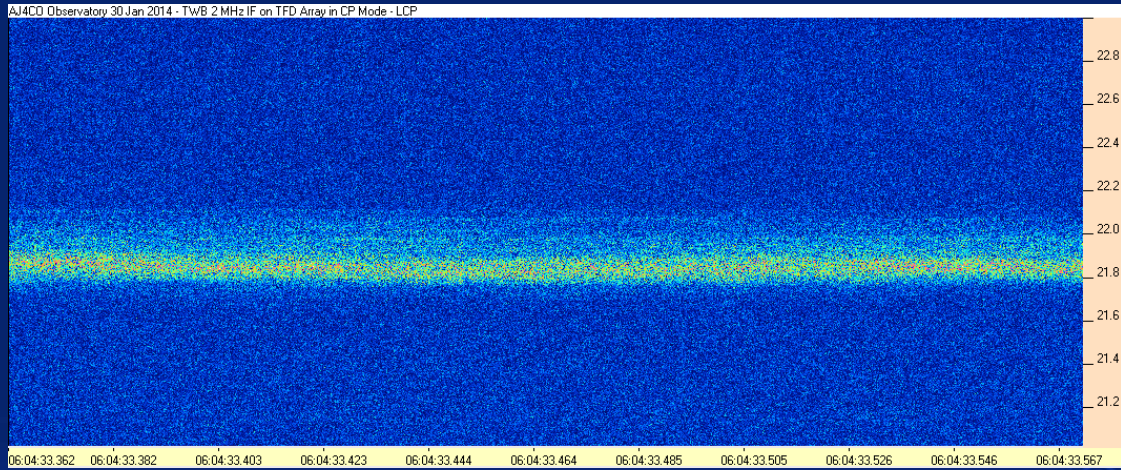

➤ 200 kHz BW

# TWB Observations – N event

10 Mar 2014, Io-C, LCP

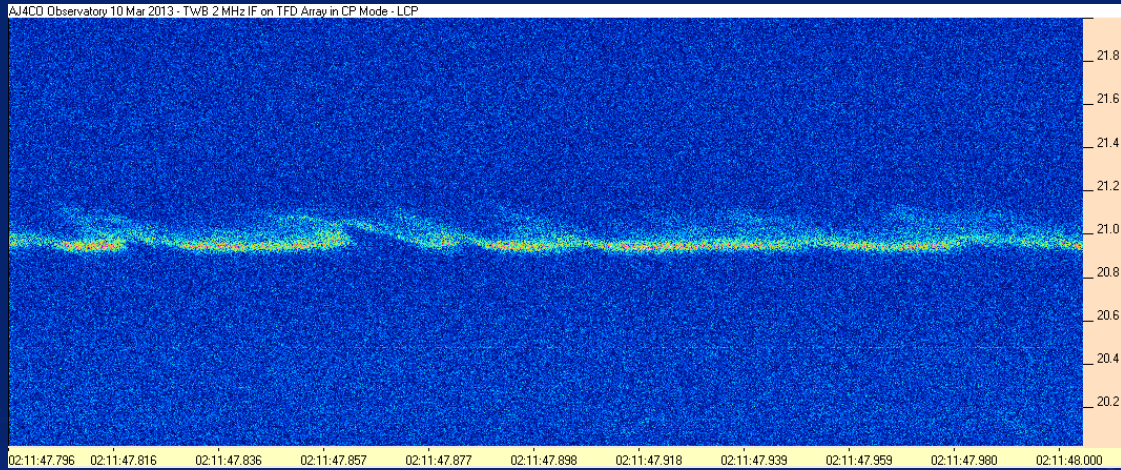

➤ ~50 kHz BW



---

Observations

SN events

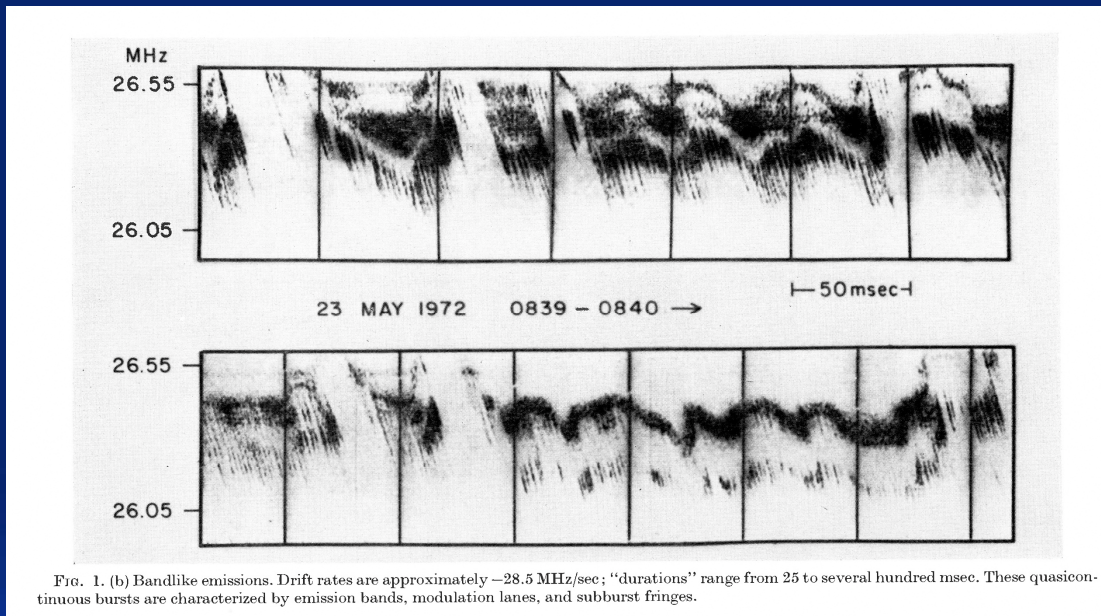

From Krausche, et al., High Resolution Spectral Analyses of the Jovian Decametric Radiation - I -  
Burst Morphology and Drift Rates, *Icarus* (1976).

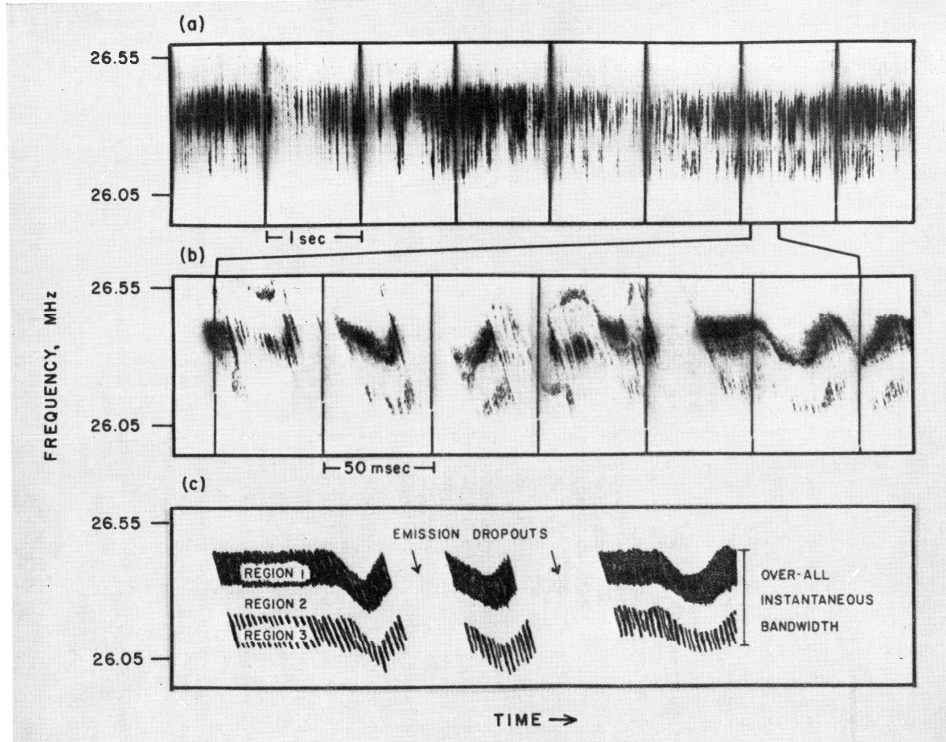
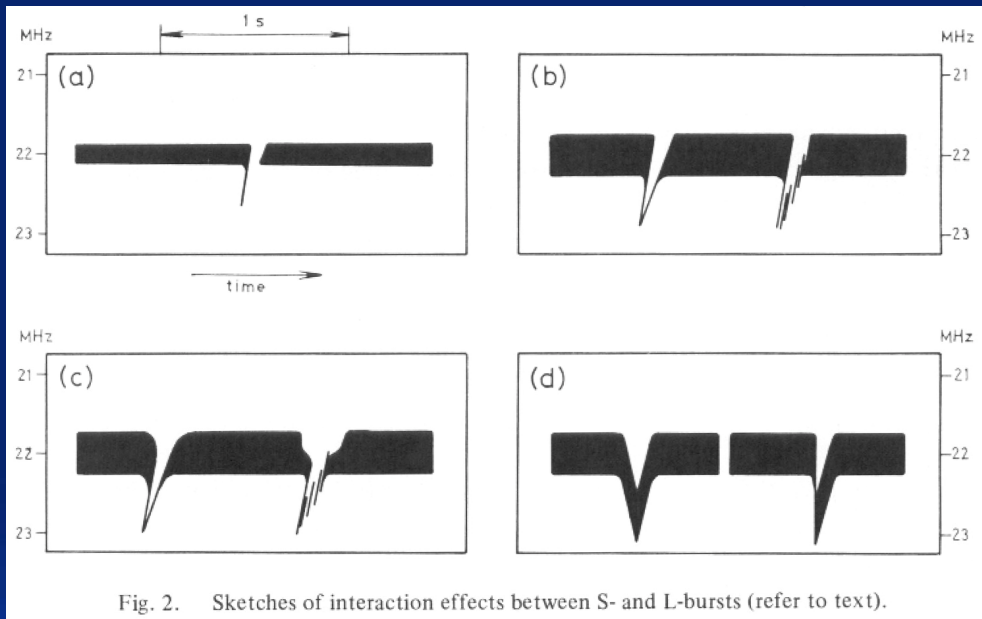
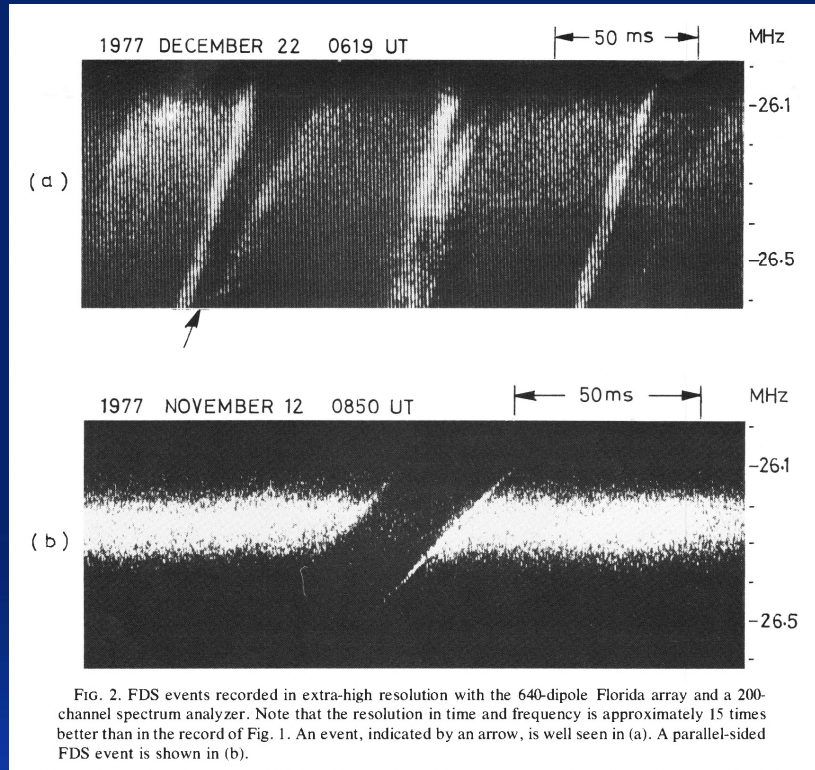

FIG. 1. (a) Low time-resolution spectrogram of the bandlike emission. (b) High time-resolution spectrogram showing an expanded 300 msec segment of (a). (c) Idealized bandlike emission.

From Flagg, et al., High Resolution Spectral Analyses of the Jovian Decametric Radiation - II - The Band-like Emissions, Icarus (1976).



From Riihimaa & Carr, Interaction of S- and L-Bursts in Jupiter's Decametric Radio Spectra, TM&P (1981).



From Riihimaa, et al., Fast-Drift Shadow Events in Jupiter's Decametric Radio Spectra, Icarus (1981).

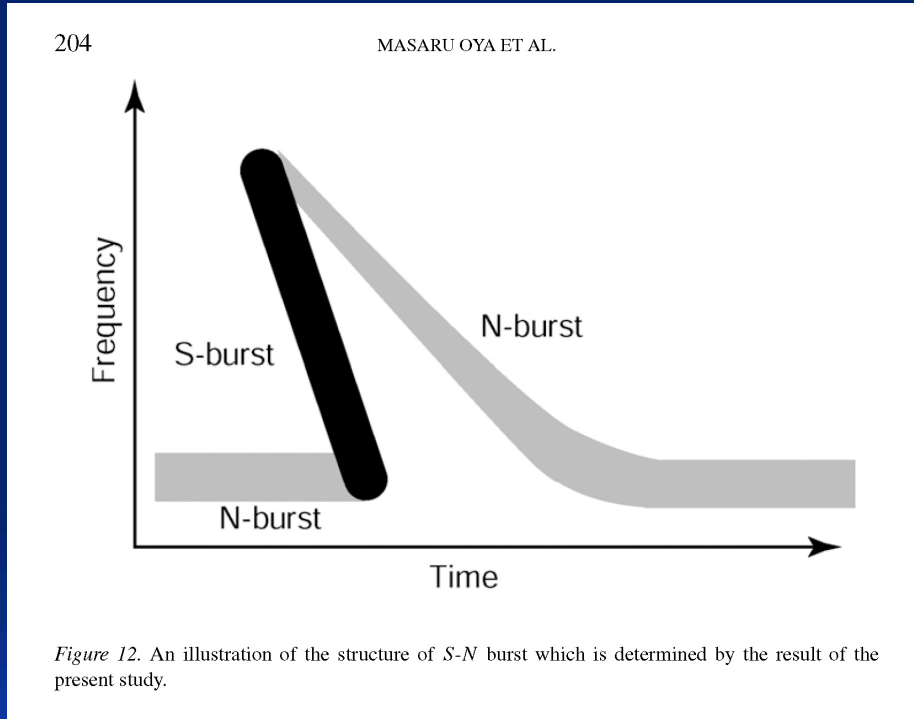

From Oya, M., et al., Analyses of Jovian Decametric Radiation S-Bursts Interacting with N-Bursts, EM&P (2002).

# TWB Observations – SN event

29 Dec 2013, Io-C, LCP

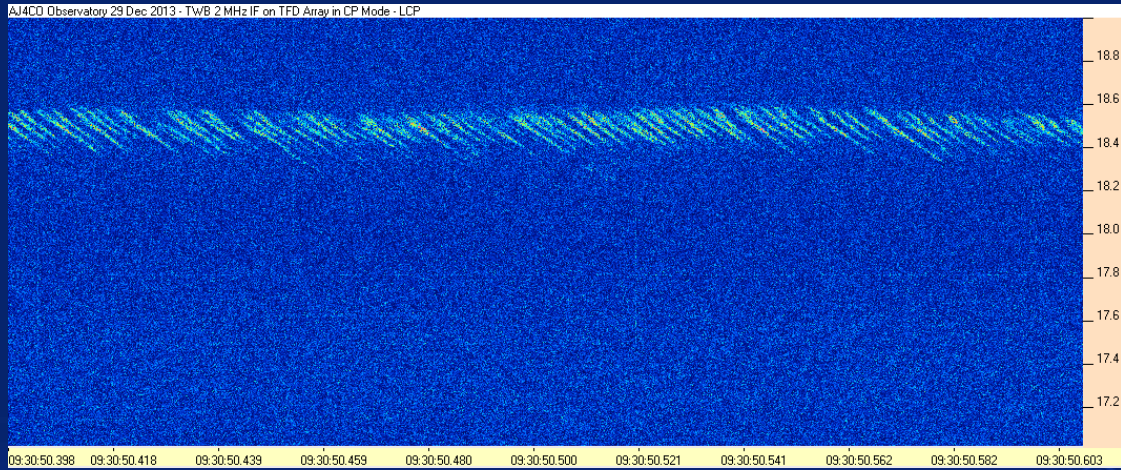

➤  $-19$  MHz/s

➤ “pure” SN

# TWB Observations – SN event

29 Dec 2013, Io-C, LCP

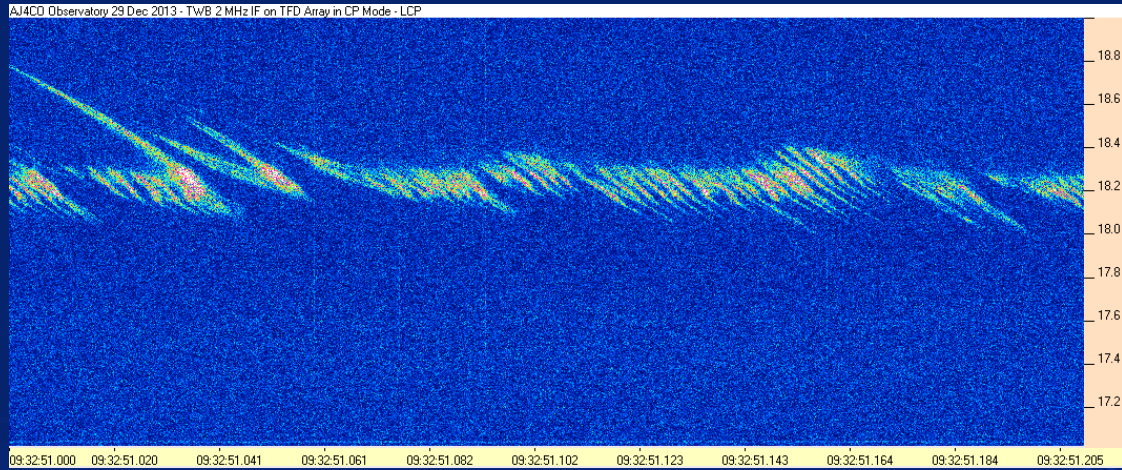

- $-19$  MHz/s
- SN + several FDS



# TWB Observations – SN event

29 Dec 2013, Io-C, LCP

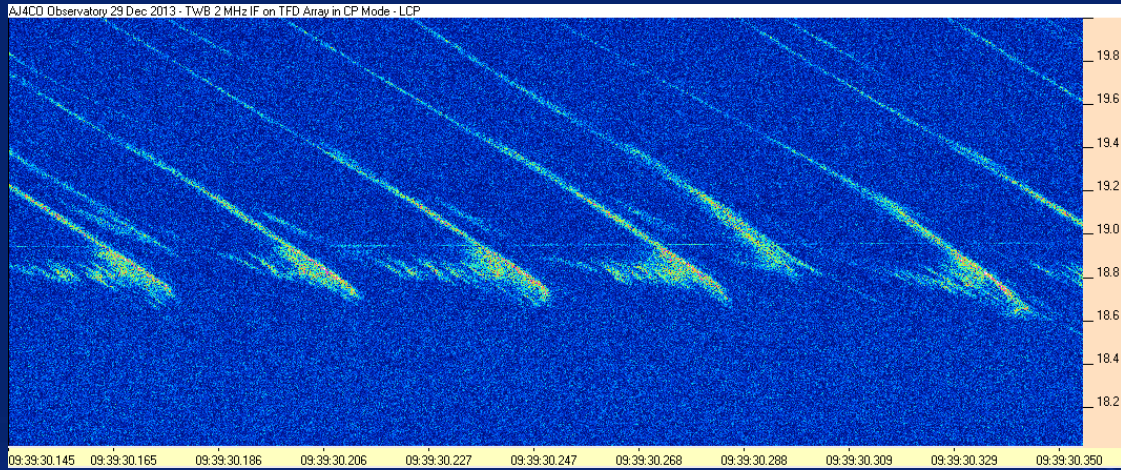

➤ -15 MHz/s

# TWB Observations – SN event

29 Dec 2013, Io-C, LCP

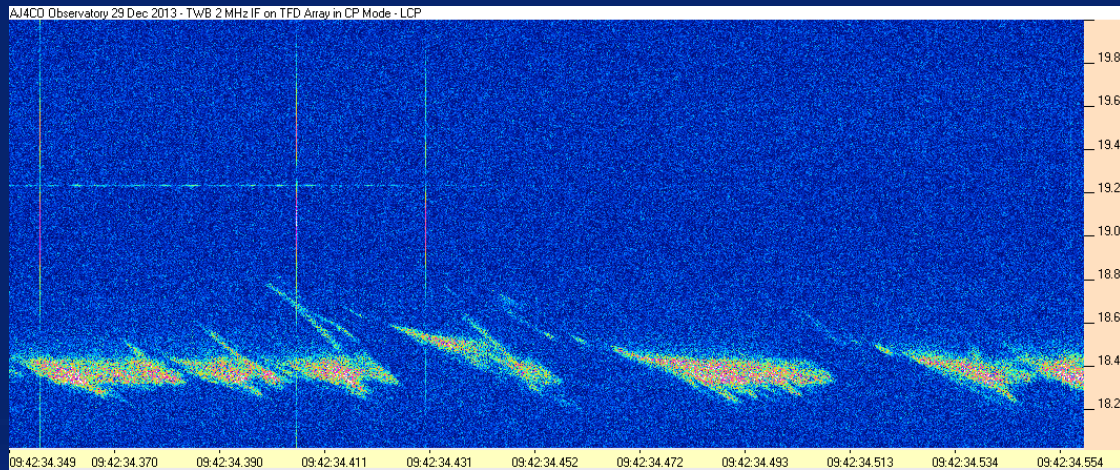

- $-20$  MHz/s
- SN + several FDS

# TWB Observations – SN event

29 Dec 2013, Io-C, LCP

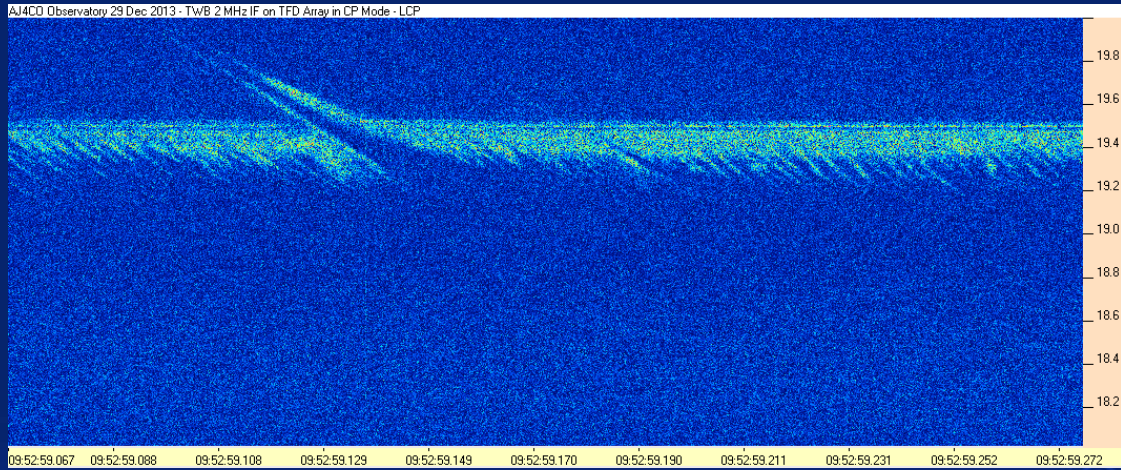

- $-17$  MHz/s
- SN, N, FDS

# TWB Observations – SN event

29 Dec 2013, Io-C, LCP

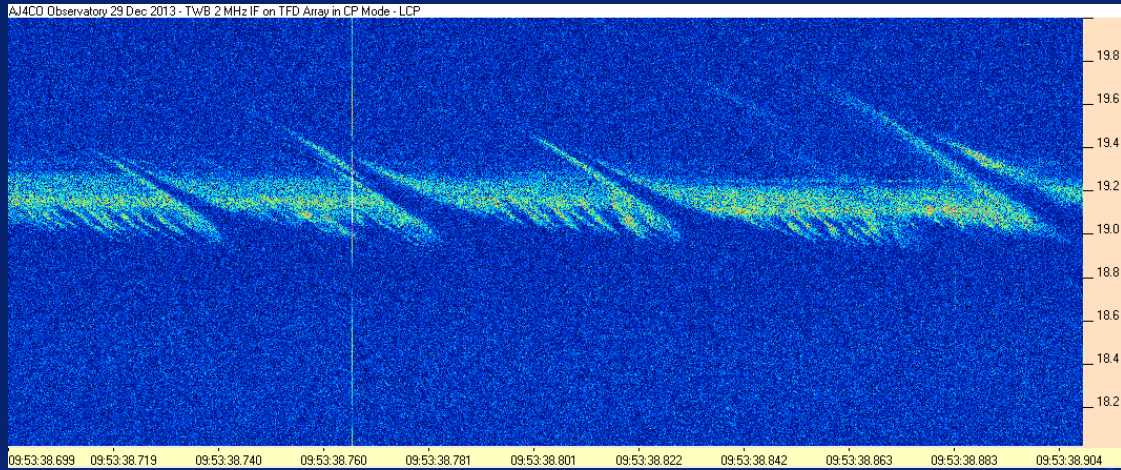

- $-21 \text{ MHz/s}$
- SN + N + FDS

# TWB Observations – SN event

29 Dec 2013, Io-C, LCP

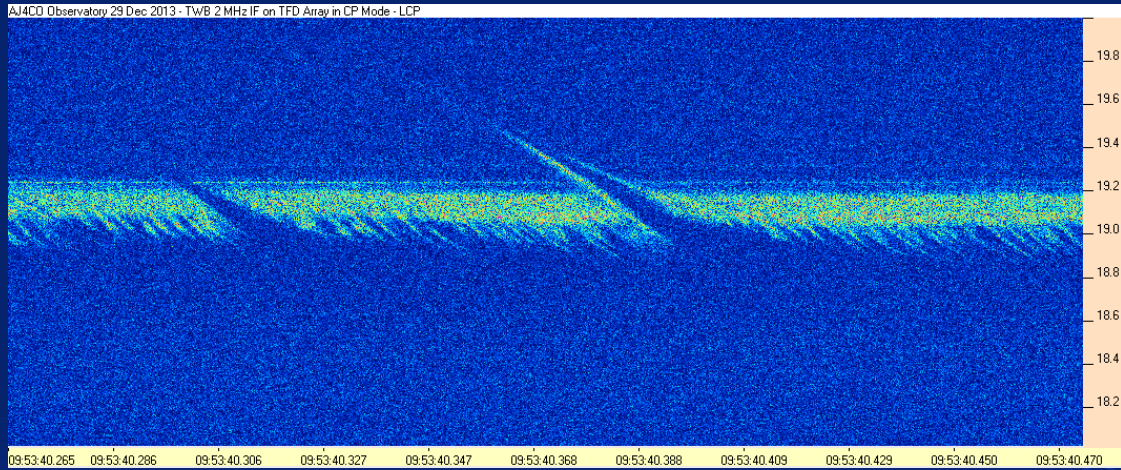

- $-21 \text{ MHz/s}$
- SN + N + FDS

# TWB Observations – SN event

30 Jan 2014, Io-C, LCP

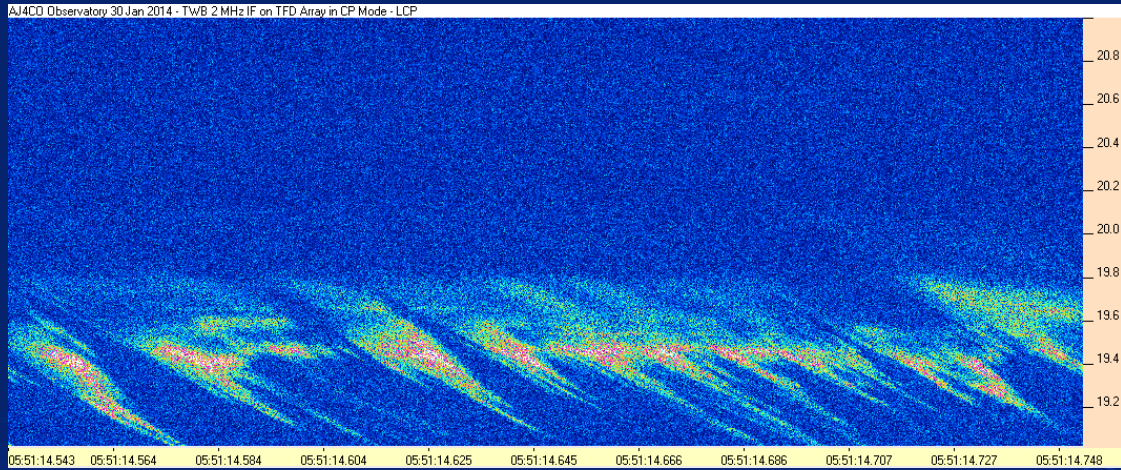

➤ -13 MHz/s

---

## Observations

# S bursts + N events

# TWB Observations – S + N

30 Dec 2013, Io-B, RCP

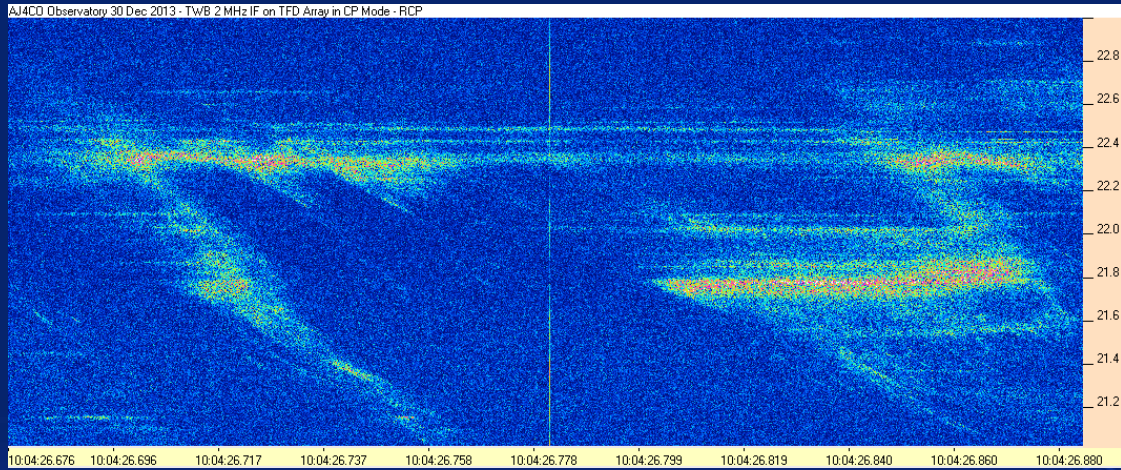

- $-17$  MHz/s
- N BW from 15 to 150 kHz



# TWB Observations – S + N

30 Dec 2013, Io-B, RCP

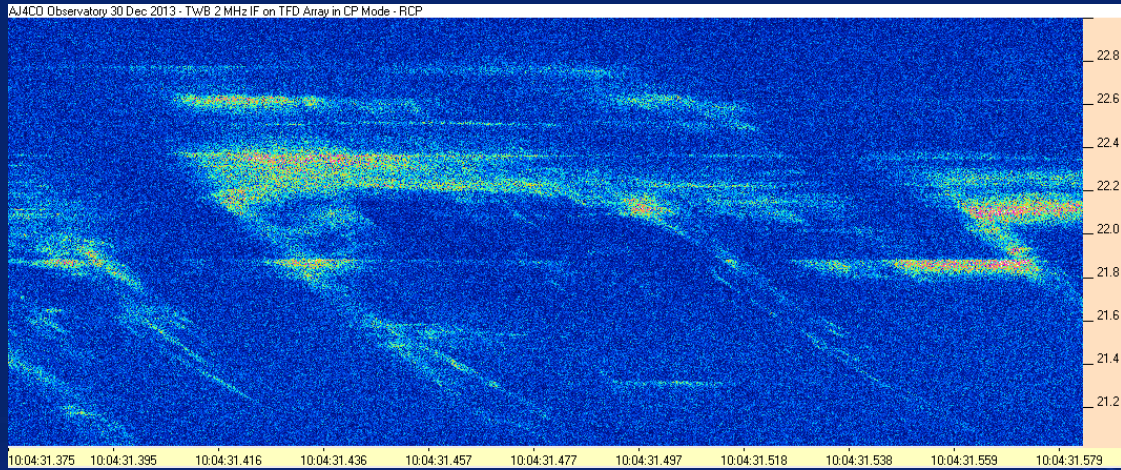

➤ -17 MHz/s

# TWB Observations – S + N

30 Dec 2013, Io-B, RCP

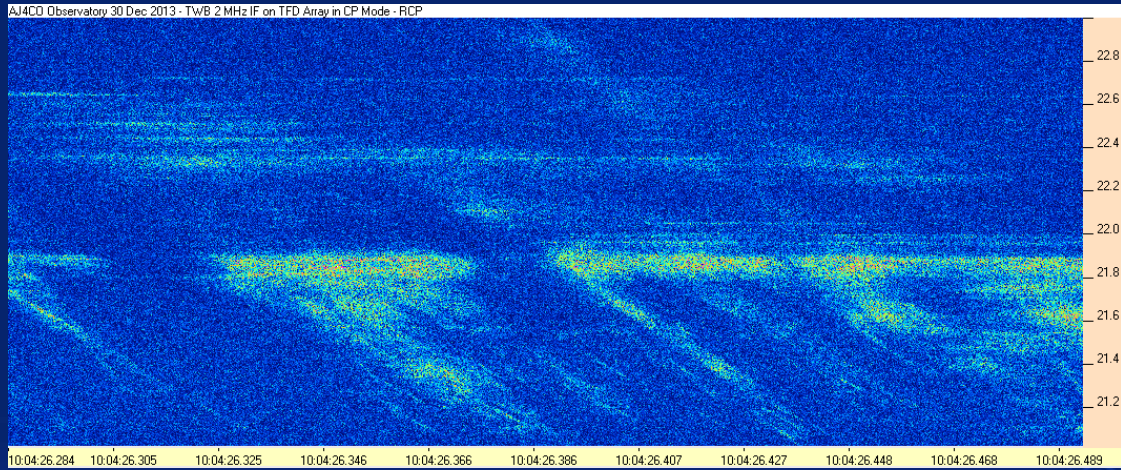

➤ -17 MHz/s

---

Observations

S bursts  
+ L Bursts  
+ N events

# TWB Observations – S+N+L

04 Mar 2014, Io-B, RCP

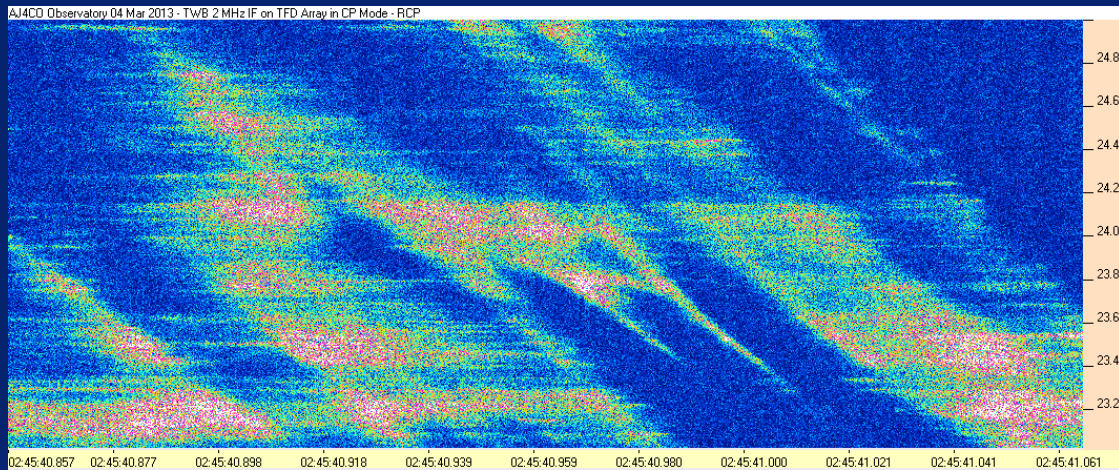

➤ -22 MHz/s features

These shadows are reminiscent of the slow drift shadow events described by Koshida[1], but drift about 4 to 5 times faster (Koshida showed shadows with a -5 MHz/s drift rate).

[1] Koshida, et al., Jovian Slow-Drift Shadow Events, JGR (2010).

# TWB Observations – S+N+L

04 Mar 2014, Io-B, RCP

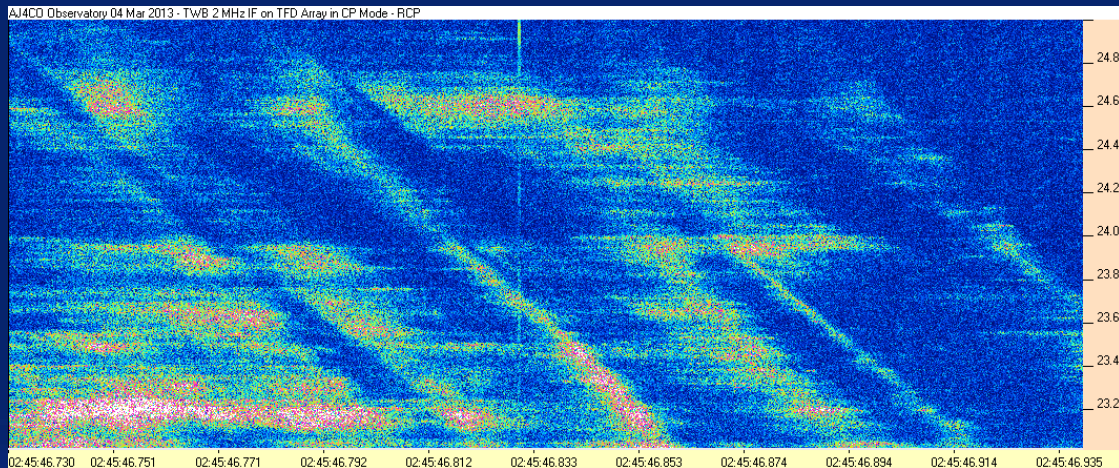

➤ -23 MHz/s features

These shadows are reminiscent of the slow drift shadow events described by Koshida[1], but drift about 4 to 5 times faster (Koshida showed shadows with a -5 MHz/s drift rate).

[1] Koshida, et al., Jovian Slow-Drift Shadow Events, JGR (2010).

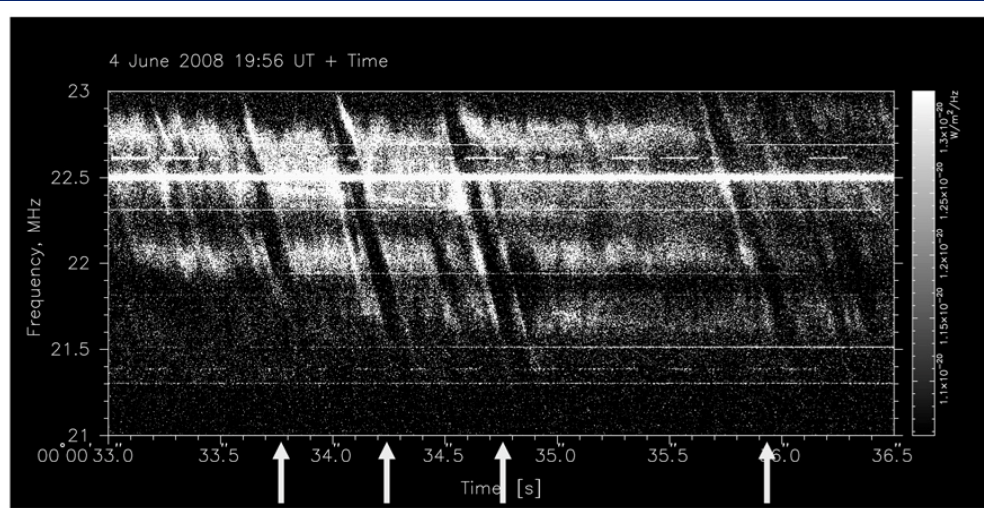

**Figure 1a.** Dynamic spectra of SDS events as observed by the developed WFR. The white levels represent higher intensity. The arrows located at the bottom indicate SDS events. SDS events quenched the background L burst emissions to the galactic background noise level. The SDS slopes had a negative drift rate of  $-5 \text{ MHz s}^{-1}$ . The amplitude of the leading and trailing edges of the SDS events sometimes showed higher intensity than that of the background L burst emissions. The intense emission at 22.5 MHz is interference.

From Koshida, et al., Jovian Slow-Drift Shadow Events, JGR (2010).

---

Observations  
Oddities

# TWB Observations – Oddities

30 Dec 2013, Io-B, RCP

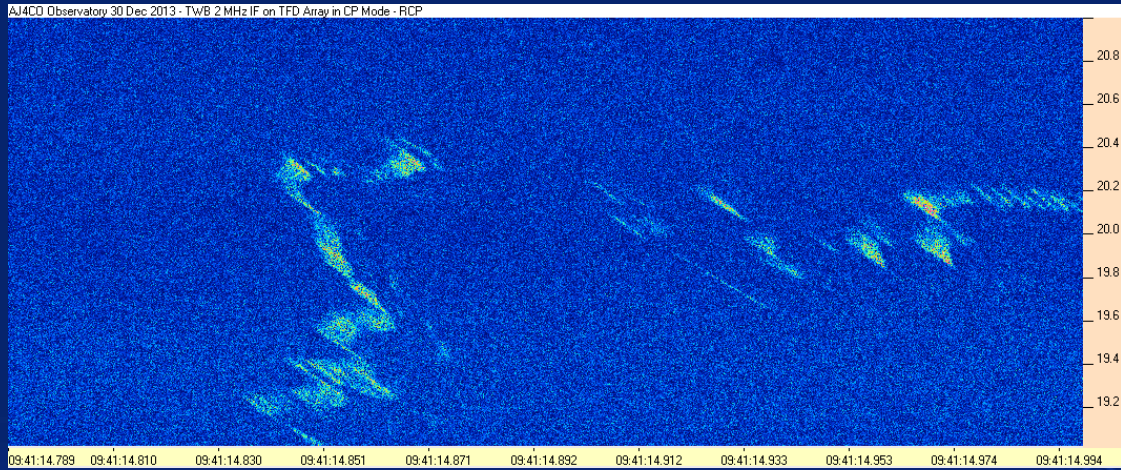



# TWB Observations – Oddities

30 Dec 2013, Io-B, RCP

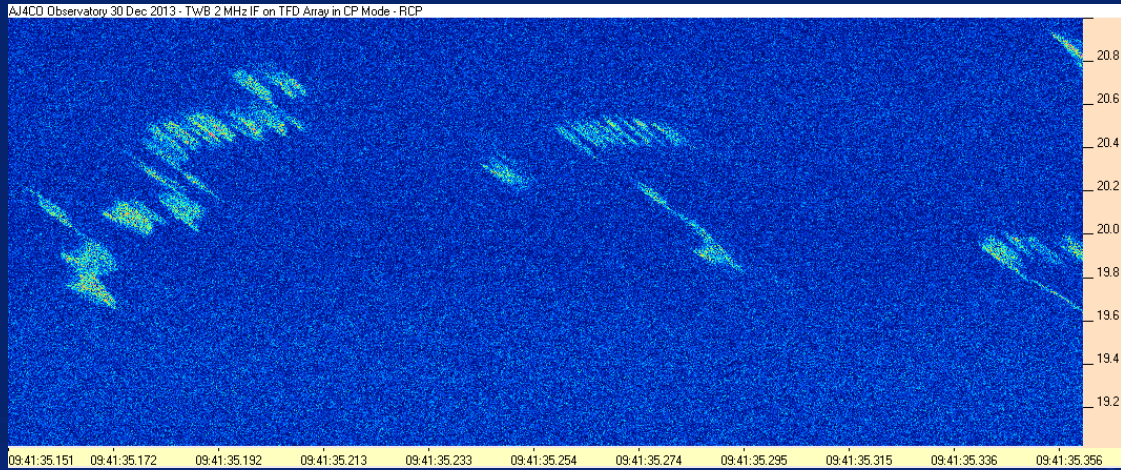

# TWB Observations – Oddities

30 Dec 2013, Io-B, RCP

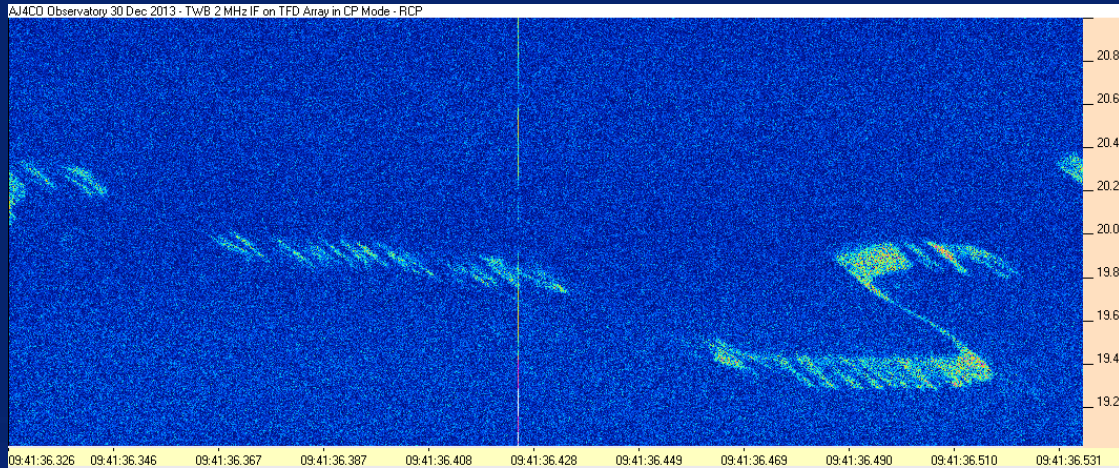

- **Not** an S burst
- Called “Z bursts” (term coined by people who plot spectrograms upside-down)

# TWB Observations – Oddities

30 Dec 2013, Io-B, RCP

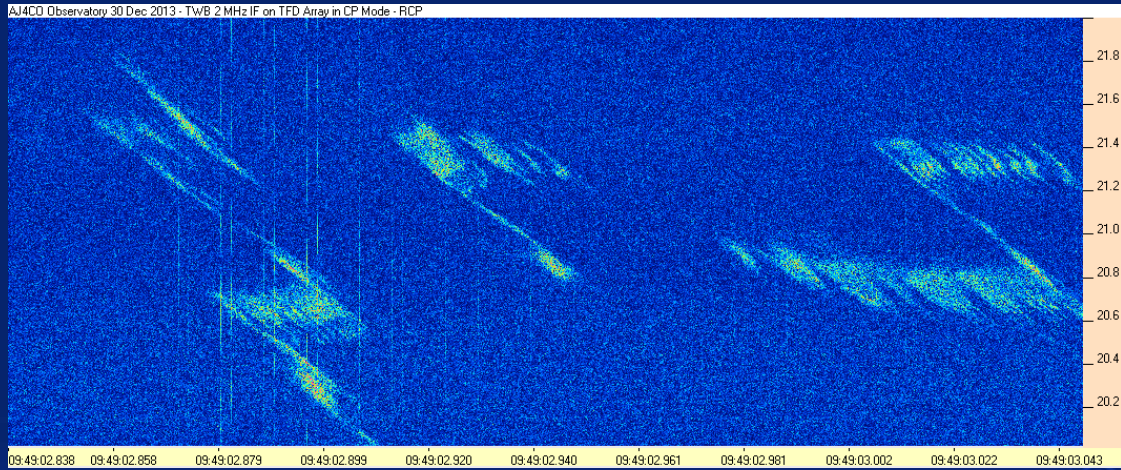

➤ Another Z burst

# TWB Observations – Oddities

30 Dec 2013, Io-B, RCP

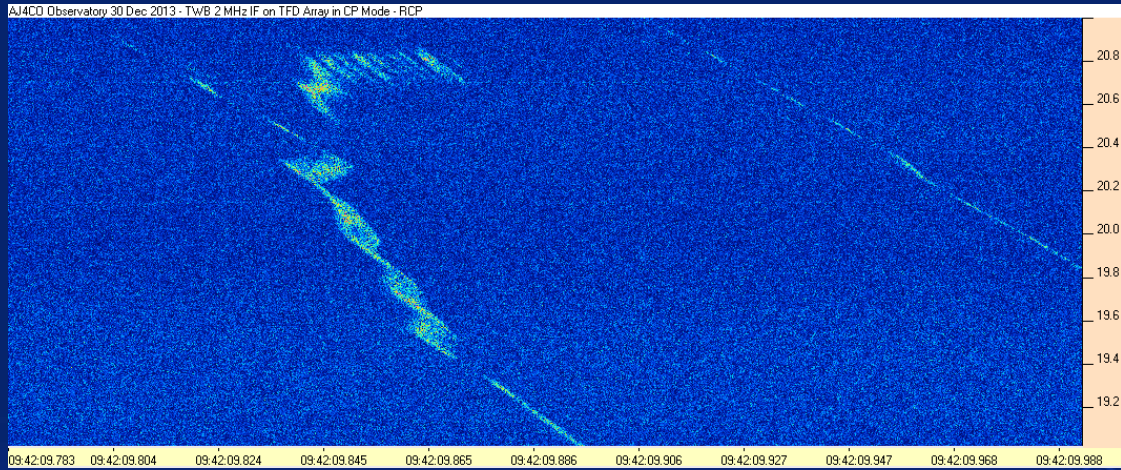

# TWB Observations – Oddities

30 Dec 2013, Io-B, RCP

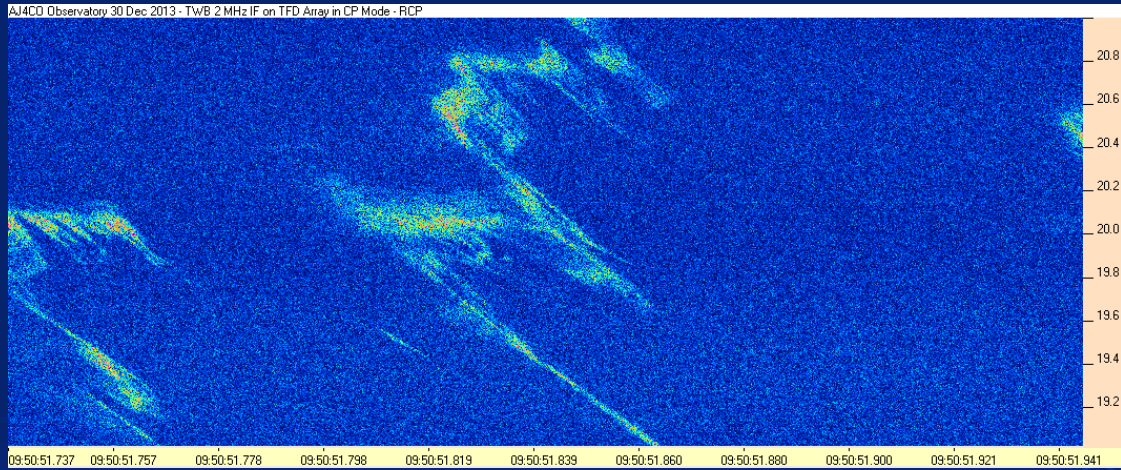

# TWB Observations – Oddities

30 Dec 2013, Io-B, RCP

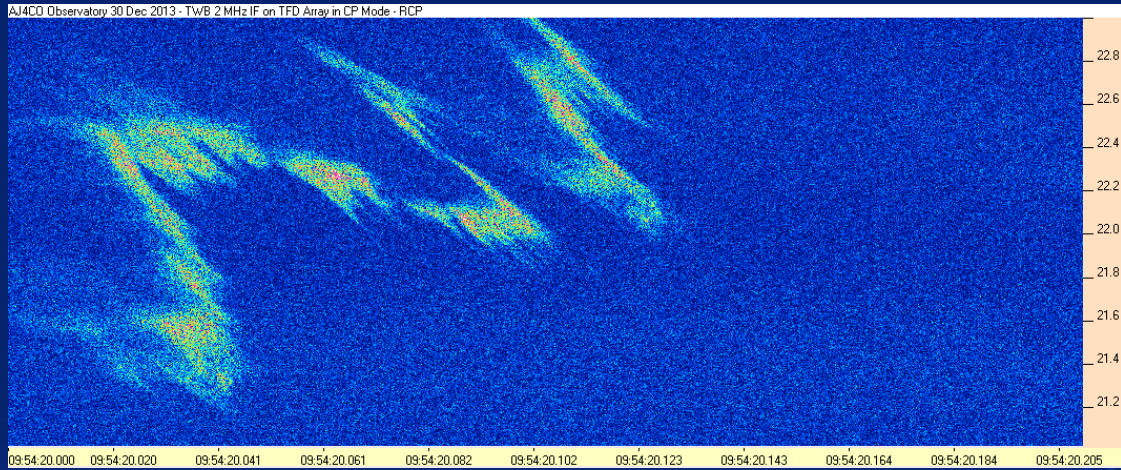

# TWB Observations – Oddities

11 Mar 2014, lo-B, RCP

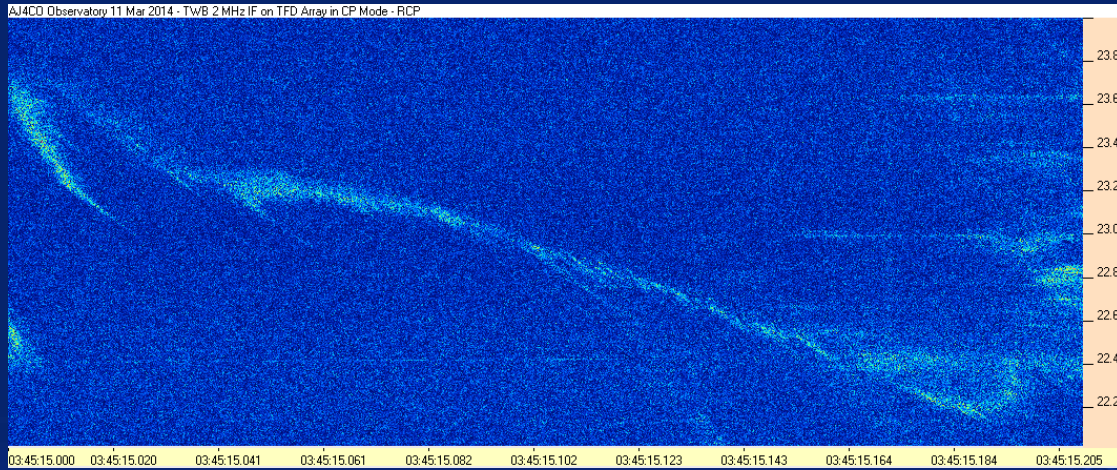

- $-8.5$  MHz/s overall
- $-19$  MHz/s features